

About this Manual

We've added this manual to the Agilent website in an effort to help you support your product. This manual is the best copy we could find; it may be incomplete or contain dated information. If we find a more recent copy in the future, we will add it to the Agilent website.

Support for Your Product

Agilent no longer sells or supports this product. Our service centers may be able to perform calibration if no repair parts are needed, but no other support from Agilent is available. You will find any other available product information on the Agilent Test & Measurement website, www.tm.agilent.com.

HP References in this Manual

This manual may contain references to HP or Hewlett-Packard. Please note that Hewlett-Packard's former test and measurement, semiconductor products and chemical analysis businesses are now part of Agilent Technologies. We have made no changes to this manual copy. In other documentation, to reduce potential confusion, the only change to product numbers and names has been in the company name prefix: where a product number/name was HP XXXX the current name/number is now Agilent XXXX. For example, model number HP8648A is now model number Agilent 8648A.

User's Guide

Publication Number E2480-97001

May 1997

For Safety Information, Warranties, and Regulatory Information, see the pages at the end of this manual.

© Copyright Hewlett-Packard Company 1997

All Rights Reserved.

HP E2480A Motorola CPU32 Preprocessor Interface

The HP E2480A Preprocessor Interface — At a Glance

The HP E2480A Preprocessor Interface provides a generic interface for state and/or timing analysis between a target system using a Motorola 68331, 68332, 68F333, 68334, 68335, 68336, 68338, or 68376 microcontroller and the following HP logic analyzers:

- HP 16550A (one- or two-card)
- HP 16554A (one- or two-card)
- HP 16555A/D (one- or two-card)
- HP 16556A/D (one- or two-card)
- HP 1660A/61A/62A, HP 1660C/61C/62C
- HP 1660AS/61AS/62AS, HP 1660CS/61CS/62CS (with oscilloscope)
- HP 1670A/71A/72A, HP 1670D/71D/72D

A probe adapter attaches to the microcontroller and, aided by a transition board, maps the package pinout to the HP E2480A PGA socket pinout. A seven-position switch on the HP E2480A is programmed to identify the target system microcontroller. This is used to configure the HP E2480A and the development environment.

Programmable, non-volatile circuitry on the HP E2480A reconstructs multiplexed microcontroller signals configured as chip selects (A19 - A23 and FC0 - FC2) or general I/O (SIZ0, SIZ1, DSACK0, and DSACK1). This allows the logic analyzer to maintain complete trigger capability and provides compatibility to HP debugging tools. The HP E3458A Processor Probe is required for programming the HP E2480A Preprocessor Interface. Information on using the Processor Probe with the HP E2480A is provided in chapter 3.

The figure on the next page shows the items used with the HP E2480A.

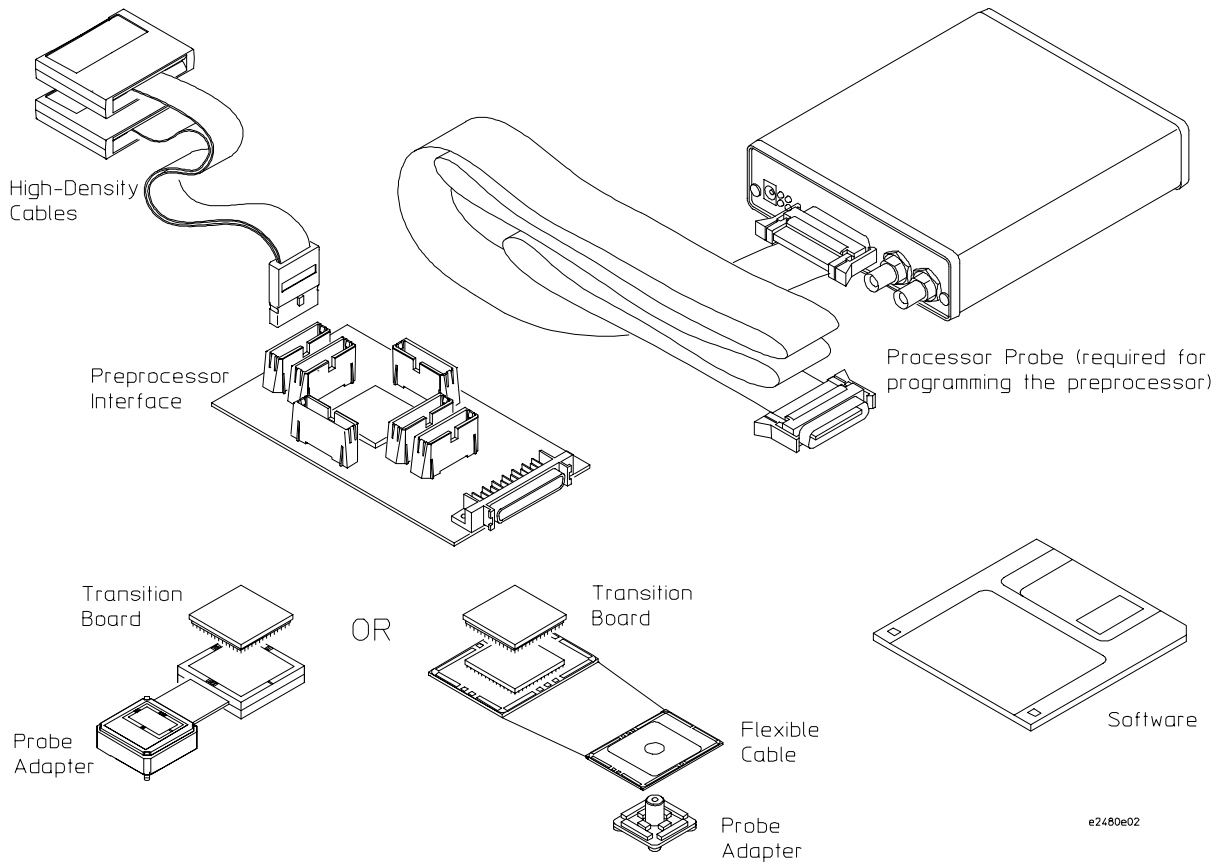

HP E2480A Preprocessor Interface with Microcontroller-specific Attachments and Optional Processor Probe

In This Book

This book is the user's guide for the HP E2480A Preprocessor Interface. It assumes that you have a working knowledge of the logic analyzer being used and the microcontroller being analyzed.

This user's guide is organized into the following chapters:

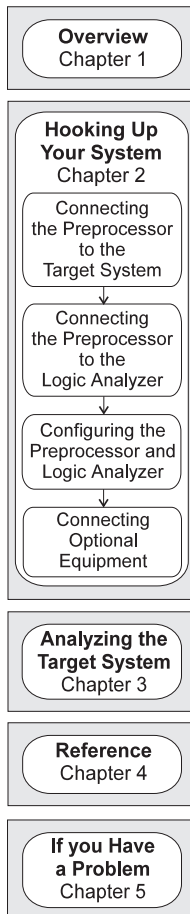

Overview

- Chapter 1 contains overview information, including a list of required equipment.

Hooking Up Your System

- Chapter 2 explains how to connect the preprocessor to your target system, how to connect the preprocessor to a logic analyzer, and how to configure the preprocessor. It also covers additional equipment supported by the HP E2480A.

Analyzing the Target System

- Chapter 3 provides information on the format specification and symbols configured by the preprocessor interface software.

Reference

- Chapter 4 contains reference information on the preprocessor interface hardware.

If you have a problem

- Chapter 5 contains troubleshooting information.

Contents

The HP E2480A Preprocessor Interface —At a Glance ii

1 Overview

Logic Analyzers Supported 1-3

Equipment Used with the Preprocessor 1-4

Equipment supplied 1-4

Minimum equipment required 1-5

Additional equipment supported 1-6

Typical setups using the preprocessor and processor probe together 1-7

Power-ON/Power-OFF Sequence 1-9

For a stand-alone logic analyzer system 1-9

For a prototype analyzer system 1-9

Connection Sequence 1-10

2 Hooking up Your System

Connecting the Preprocessor to the Target System 2-3

To connect the transition board to the preprocessor 2-4

To connect the preprocessor interface to the probe adapter 2-5

Connecting the probe adapter to the target system 2-6

132-pin PQFP Probe Adapter Rotations 2-7

144-pin TQFP Probe Adapter Rotations 2-8

160-pin QFP Probe Adapter Rotations 2-9

Connecting the Preprocessor to the Logic Analyzer 2-10

Connecting the High-density Cables to the Preprocessor Interface 2-11

Connecting the High-Density Cables to the Logic Analyzer	2-12
To connect to the HP 1660A/AS/C/CS logic analyzers	2-13
State	2-13
Timing	2-14
To connect to the HP 1661A/AS/C/CS logic analyzers	2-15
State	2-15
Timing	2-16
To connect to the HP 1662A/AS/C/CS logic analyzers	2-17
State	2-17
Timing	2-18
To connect to the HP 1670A/D logic analyzer	2-19
State	2-19
Timing	2-20
To connect to the HP 1671A/D logic analyzer	2-21
State	2-21
Timing	2-22
To connect to the HP 1672A/D logic analyzer	2-23
State	2-23
Timing	2-24
To connect to the HP 16550A logic analyzer	2-25
State	2-25
Timing (one card)	2-26
Timing (two card)	2-27
To connect to the HP 16554/55/56 logic analyzers	2-28
State	2-28
Timing (One or Two Card)	2-29
Configuring the Preprocessor and Logic Analyzer	2-30
Configuring the preprocessor interface	2-31
To set the ID switches	2-31
To interpret the LEDs	2-32
Downloading a configuration	2-34
Configuring With a Debugger	2-34
Configuring With the HP 16505A Prototype Analyzer	2-34

- Configuring the Logic Analyzer 2-36
- To load the configuration and inverse assembler 2-36

- Connecting Optional Equipment 2-38
- To connect the HP E3458A Processor Probe 2-39
- To connect the HP 16505A Prototype Analyzer 2-39

3 Analyzing the Target System

- Modes of Operation 3-3
 - State mode 3-3
 - Timing mode 3-3

- Format Menu 3-4
 - Status bit definition and encodings 3-6

- Using the Inverse Assembler 3-8
 - To display captured state data 3-8
 - To synchronize the inverse assembler 3-9
 - General output format 3-10
 - Inverse assembler error messages 3-12
 - Clock qualifiers 3-12

4 Reference

- Operating Characteristics 4-3
- Theory of Operation and Clocking 4-4
 - Timing 4-4
 - State 4-4
- Address reconstruction overview 4-5
- Signal-to-connector mapping (Timing) 4-7
- State connector signal definition 4-15
- Repair Strategy 4-19

- Circuit Board Dimensions 4-20

5 If You Have a Problem

Analyzer Problems 5-3

Intermittent data errors 5-3

Unwanted triggers 5-3

No activity on activity indicators 5-4

No trace list display 5-4

Analyzer won't power up 5-4

Preprocessor Problems 5-5

Target system will not boot up 5-5

Erratic trace measurements 5-6

Capacitive loading 5-6

Inverse Assembler Problems 5-7

No inverse assembly or incorrect inverse assembly 5-7

Inverse assembler will not load or run 5-8

Intermodule Measurement Problems 5-9

An event wasn't captured by one of the modules 5-9

Messages 5-10

“. . . Inverse Assembler Not Found” 5-10

“Measurement Initialization Error” 5-11

“No Configuration File Loaded” 5-12

“Selected File is Incompatible” 5-12

“Slow or Missing Clock” 5-12

“Time from Arm Greater Than 41.93 ms” 5-13

“Waiting for Trigger” 5-13

Cleaning the Instrument 5-14

Overview

Overview

This chapter describes:

- Logic analyzers supported
- Equipment used with the preprocessor
- Typical setups using the preprocessor and processor probe together
- Power-on/power-off sequence
- Connection sequence

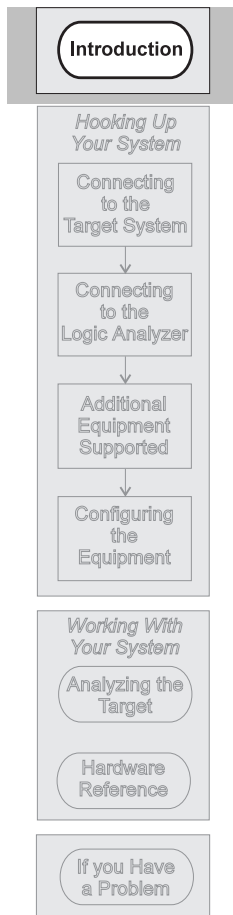

Logic Analyzers Supported

For the HP 16500B mainframe, software revision 3.04 or higher is recommended. For the HP 16500C mainframe, software revision 1.0 or higher is recommended.

Logic Analyzer	Channel Count	State Speed	Timing Speed	Memory Depth
1660A/AS/C/CS	136	100 MHz	250 MHz	4 k states
1661A/AS/C/CS	102	100 MHz	250 MHz	4 k states
1662A/AS/C/CS	68	100 MHz	250 MHz	4 k states
1670A/71A/72A	136/102/68	70 MHz	125 MHz	64 k or .5 M states
1670D/71D/72D	136/102/68	100 MHz	250 MHz	64 k or 1 M states
16550A (one or two cards)	102/card	100 MHz	250 MHz	4 k states
16554A (one or two cards)	68/card	70 MHz	125 MHz	512 k states
16555A (one or two cards)	68/card	110 MHz	250 MHz	1 M states
16555D (one or two cards)	68/card	110 MHz	250 MHz	2 M states
16556A (one or two cards)	68/card	100 MHz	200 MHz	1 M states
16556D (one or two cards)	68/card	100 MHz	200 MHz	2 M states

Additional Equipment Supported

HP 16505A Prototype Analyzer
HP E3458A Processor Probe

Requirements/Features

Software Version Required: A.01.22 or higher
Provides Run Control connection to the target system.
Refer the *HP E3458A Processor Probe User's Guide* for operating instructions.

Equipment Used with the Preprocessor

This section lists equipment that can be used with this preprocessor when it is connected to one of the logic analyzers listed on the preceding page. This information is organized under the following titles:

- Equipment supplied
- Minimum equipment required
- Additional equipment supported

Equipment supplied

If you ordered the HP E2480A Preprocessor Interface, you received:

- The HP E2480A Preprocessor Interface circuit board.
- The logic analyzer configuration and inverse assembler software on five 3.5-inch disks.
- Configuration software for the HP 16505A Prototype Analyzer software on a 3.5-inch disk.
- This User's Guide.

If you ordered a microcontroller-specific preprocessor package (HP E81xxA) you received:

- The HP E2480A Preprocessor Interface, which includes the circuit board, configuration software, and the User's Guide.
- Four HP E5346A high-density cables.
- A microcontroller-specific transition board.
- A QFP probe adapter kit for your specific microcontroller package. The probe adapter also comes with a User's Guide.

Minimum equipment required

For state and/or timing analysis of a Motorola CPU32 target system, you need all of the following:

- The HP E2480A Preprocessor Interface, which includes the circuit board, configuration software, and the User's Guide.
- Two HP E5346A high-density cables.
- A microcontroller-specific transition board.
- A QFP probe adapter kit for your specific microcontroller package.
- The probe adapter User's Guide, for connecting the probe adapter to the target system.
- One of the supported logic analyzers. For the HP 165xx logic analyzer modules, an HP 16500B or HP 16500C mainframe is required.

The above is the minimum equipment required to make a measurement. If you want to configure the preprocessor interface to reconstruct addresses, you must also have the HP 3458A Processor Probe.

Additional equipment supported

An HP E3458A Processor Probe can be connected through the HP E2480A to the target system. This eliminates the need for target-system connectors for run control. The processor probe allows the user to halt execution, download code, read/write memory and registers, and step through software. Example connections of a processor probe are shown in the typical setups on the next pages. The procedure for connecting a processor probe is given at the end of Chapter 2.

The E3458A Processor Probe is provided with a graphical user interface running on the HP 16505A Prototype Analyzer. You can control target system operation directly from the HP 16505A. Registers and memory can be displayed and modified. Target code can be displayed in assembly language.

The E3458A graphical user interface is used to configure the E2480A preprocessor interface for address reconstruction. Configure the preprocessor as follows:

- 1** If the target system contains initialization code, run the target system until initialization of the SIM registers is complete. The target processor can be stopped by using a software breakpoint or with the "break" button.
- 2** Press the "Read Configuration" button in the processor probe "Configuration" window."
- 3** Press the "Load Preprocessor" button in the "Configuration" window. The preprocessor interface is now ready for address reconstruction.

If your target system does not contain initialization code, manually modify the SIM register values in the "Configuration" window according to your target system specification. Then repeat Step 3, above.

Typical setups using the preprocessor and processor probe together

The illustrations in this section show typical equipment setups. The setup you choose will depend on the type of development or test you are performing (hardware or software), and the type of logic analyzer you are using.

The preprocessor interface supplies signals from the target microcontroller to the logic analyzer. A configuration file sets up the logic analyzer to properly interpret these signals.

The preprocessor probe allows you to load program code and run it on the target system.

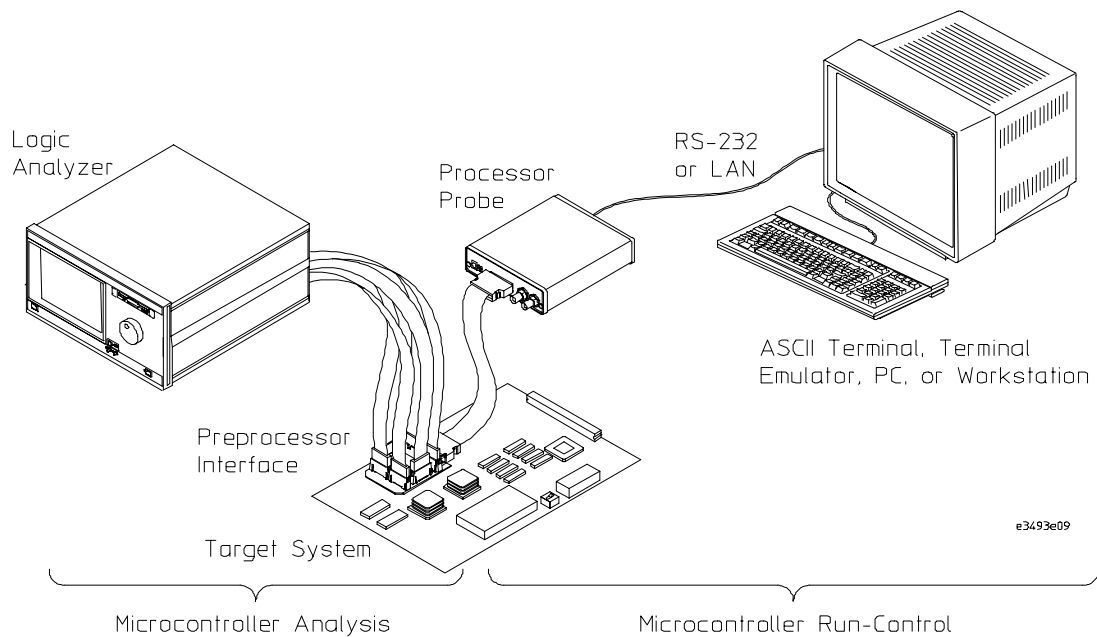

Hardware Designer's Solution using a Logic Analyzer, Preprocessor, and Processor Probe

Chapter 1: Overview
Typical setups using the preprocessor and processor probe together

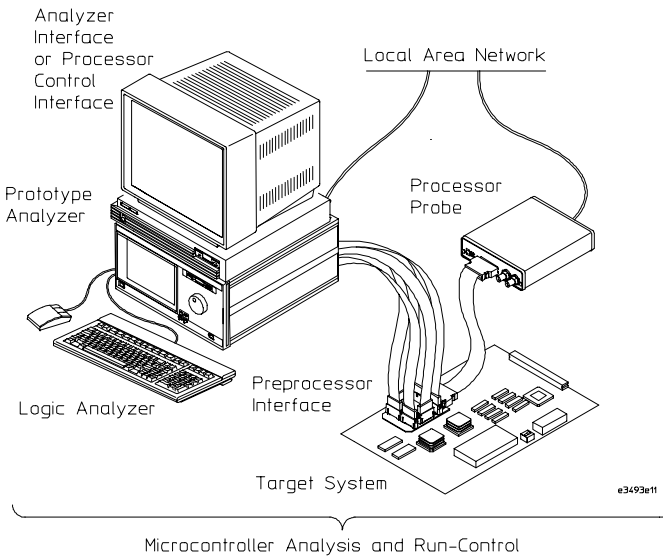

Hardware Designer's Solution using a Prototype Analyzer, Preprocessor, and Processor Probe

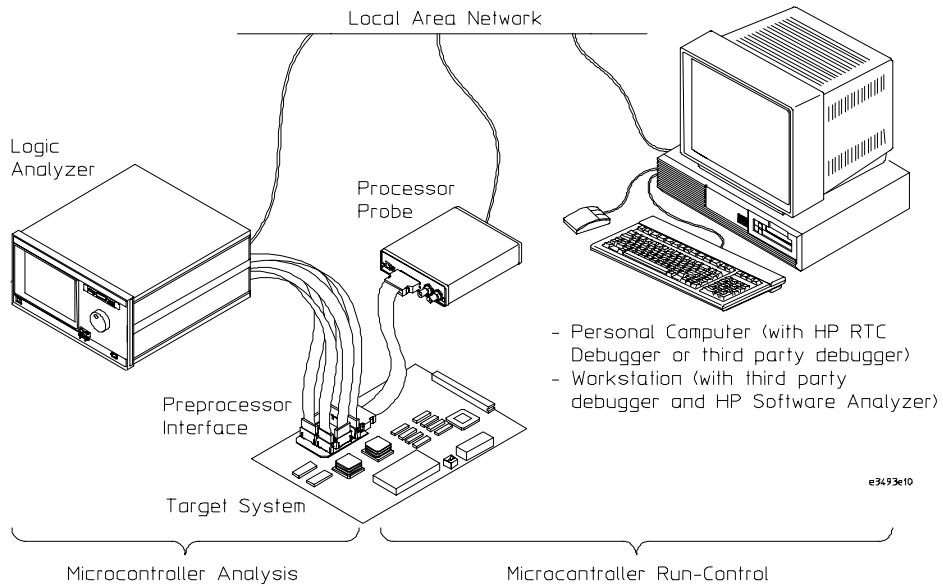

Software Designer's Solution using a PC or Workstation, Preprocessor, and Processor Probe

Power-ON/Power-OFF Sequence

Listed below are the sequences for powering on and off a fully-connected preprocessor system. Simply stated, your target system is always the last to be powered ON.

For powering OFF, the target system is the first to be powered OFF, then the processor probe (if you have one), then the logic analyzer.

The HP E2480A Preprocessor Interface can be powered from either a logic analyzer or the software probe. If both devices are attached to the preprocessor, the logic analyzer supplies the power. If the logic analyzer cables are removed while the preprocessor is connected to either a powered target or the software probe, the preprocessor may appear to be powered, but it isn't. If this occurs, power off or remove all devices attached to the preprocessor, then reattach or repower in the proper sequence so that the preprocessor interface correctly identifies the power source.

For a stand-alone logic analyzer system

With all components connected, power on your system in the following order:

1. Logic analyzer.
2. Processor probe (if you have one).
3. Target system.

For a prototype analyzer system

1. Turn on the prototype analyzer system. The Measurement Setup Assistant will guide you through the process of connecting and configuring.
2. When the system is configured, turn on your processor probe (if you have one), and finally turn on your target system.

Connection Sequence

This manual supports connecting the preprocessor to a stand-alone logic analyzer or to a prototype analyzer system.

Disconnect power from the logic analyzer and your target system before you make or break connections. If you have a processor probe, also disconnect its power.

The connection flow is as follows:

1. Set switches, if necessary, on the preprocessor board.
2. Connect the transition board to the preprocessor interface.
3. Connect preprocessor/transition board to the probe adapter.
4. Connect the probe adapter to the target system.
5. Connect the logic analyzer cables to the preprocessor interface.
6. If you have a processor probe, connect it to the preprocessor.
7. If you have a processor probe, connect it to your controller (prototype analyzer, workstation, PC).
8. Load configuration and inverse assembler files into the logic analyzer.
9. If you have a prototype analyzer, load the prototype analyzer configuration files into the prototype analyzer.

Hooking up Your System

Hooking up your System

This chapter shows you how to connect your logic analyzer to your target system through the preprocessor interface. It also shows how to connect additional equipment to obtain special features, if desired.

This chapter is divided into the following sections:

- Connecting the preprocessor to the target system.
- Connecting the preprocessor to the logic analyzer.
- Configuring the system.
- Connecting additional equipment.

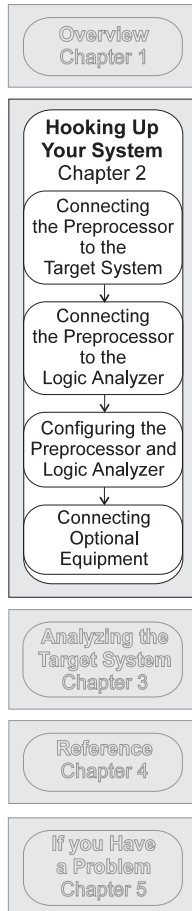

Connecting the Preprocessor to the Target System

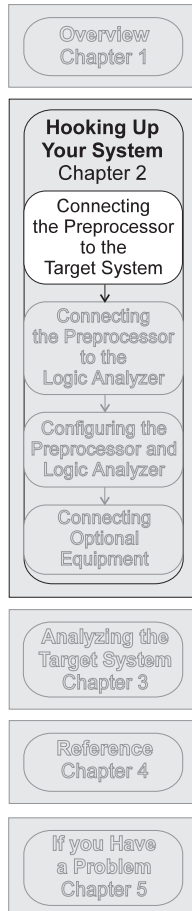

This chapter explains how to connect the HP E2480A Preprocessor Interface to the target system. Connecting to the target system consists of the following steps:

- Connecting the probe adapter to the target system.

Note that there are separate instructions for the different QFP packages. The instructions in this manual are only an overview. Use the Users Guide included with your probe adapter for detailed connecting procedures.

- Connecting the transition board to the preprocessor interface.
- Connecting the preprocessor interface/transition board to the probe adapter on the target system.

The remainder of this section describes these general steps in more detail.

The preprocessor interface socket assembly pins are covered for shipment with a conductive foam wafer or conductive plastic pin protector. This is done to protect the delicate gold-plated pins from damage due to impact. When you're not using the preprocessor interface, protect the socket assembly pins from damage by covering them with the pin protector.

To connect the transition board to the preprocessor

The microcontroller-specific transition board properly routes the signals from the probe adapter to the preprocessor interface. To connect the transition board to the preprocessor:

- Verify that there are no bent pins on the PGA socket of the preprocessor.
- Align the beveled corner of the transition board with the pin A1 corner of the PGA connector on the underside of the preprocessor. The illustration below shows the beveled corner and the pin A1 corner, as seen from the top of the preprocessor interface.

CAUTION

Serious damage to the target system or preprocessor interface can result from incorrect connection. Note the position of pin 1 (or pin A1) on the target system, transition board, and the preprocessor interface prior to making any connection. Also, take care to align the preprocessor interface connector with the pins on the probe adapter assembly so that all pins are making contact.

- Once all pins are aligned correctly, firmly press the transition board onto the preprocessor PGA socket. You might need a solid surface to press against.

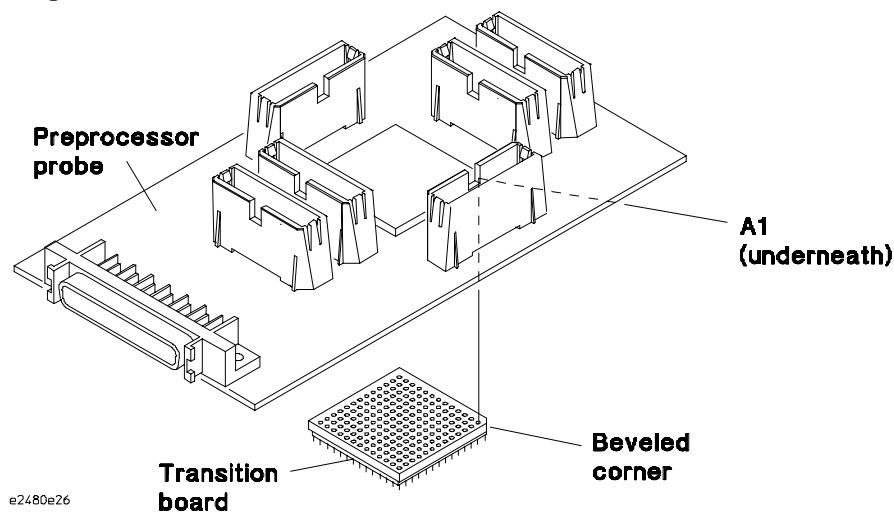

Pin A1 Corner and Transition Board Alignment

To connect the preprocessor interface to the probe adapter

The orientation of the preprocessor interface with respect to the probe adapter depends on the orientation of the probe adapter with respect to pin 1 of the target system. Use the appropriate illustration from the following pages to ensure you have the proper orientation. To connect the preprocessor interface to the probe adapter:

- Verify that there are no bent pins on the PGA socket of the transition board.
- Note the color (or number of black squares) on the side of the probe adapter or flexible cable that is connected to the pin 1 side of the target system microcontroller. Orient the preprocessor so that the solid white side of the transition board aligns with the same color (or number of black squares) on the PGA end of the probe adapter or flexible cable.

CAUTION

Serious damage to the target system or preprocessor interface can result from incorrect connection. Note the position of pin 1 (or pin A1) on the target system, transition board, and the preprocessor interface prior to making any connection. Also, take care to align the preprocessor interface connector with the pins on the probe adapter assembly so that all pins are making contact.

- Once all pins are aligned correctly, firmly press the preprocessor interface/transition board onto the PGA socket of the probe adapter or flexible cable.

Connecting the probe adapter to the target system

The CPU microcontrollers supported by the HP E2480A Preprocessor Interface come in a variety of QFP packages. The QFP probe adapter assemblies allow the preprocessor interface to be connected to the target system without removing the microcontroller from the target system. Refer to the Probe Adapter Users Guide (included with your HP E81xxA order) for information on attaching the QFP Probe Adapter to your target system.

The illustrations on the following pages show the allowable rotations for the different QFP probe adapters when used with the HP E2480A. Note that the orientation (rotation) of the preprocessor with respect to the probe adapter depends on the orientation (rotation) of the probe adapter with respect to the target system. To ensure that you do not have mechanical interference between the preprocessor interface and the target system, use the rotation diagrams on the following pages, and the instructions in "To connect the preprocessor interface to the probe adapter," to determine the desired orientation before you connect the probe adapter to the target system.

CAUTION

Serious damage to the target system or preprocessor interface can result from incorrect connection. Note the position of pin 1 (or pin A1) on the target system, transition board, and the preprocessor interface prior to making any connection. Also, take care to align the preprocessor interface connector with the pins on the probe adapter assembly so that all pins are making contact.

CAUTION

To prevent equipment damage, remove power from all system components before making attachments.

132-pin PQFP Probe Adapter Rotations

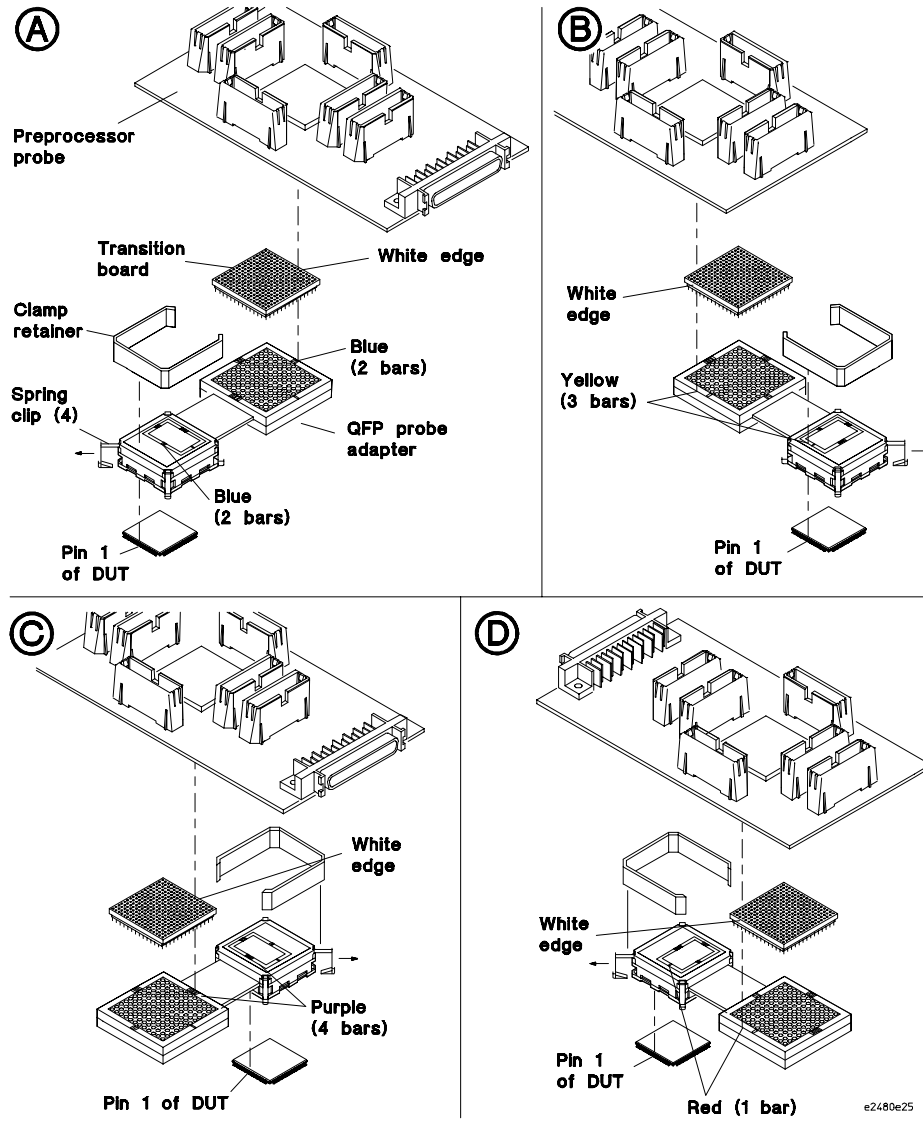

132-Pin PQFP Probe Adapter Rotation Diagram

144-pin TQFP Probe Adapter Rotations

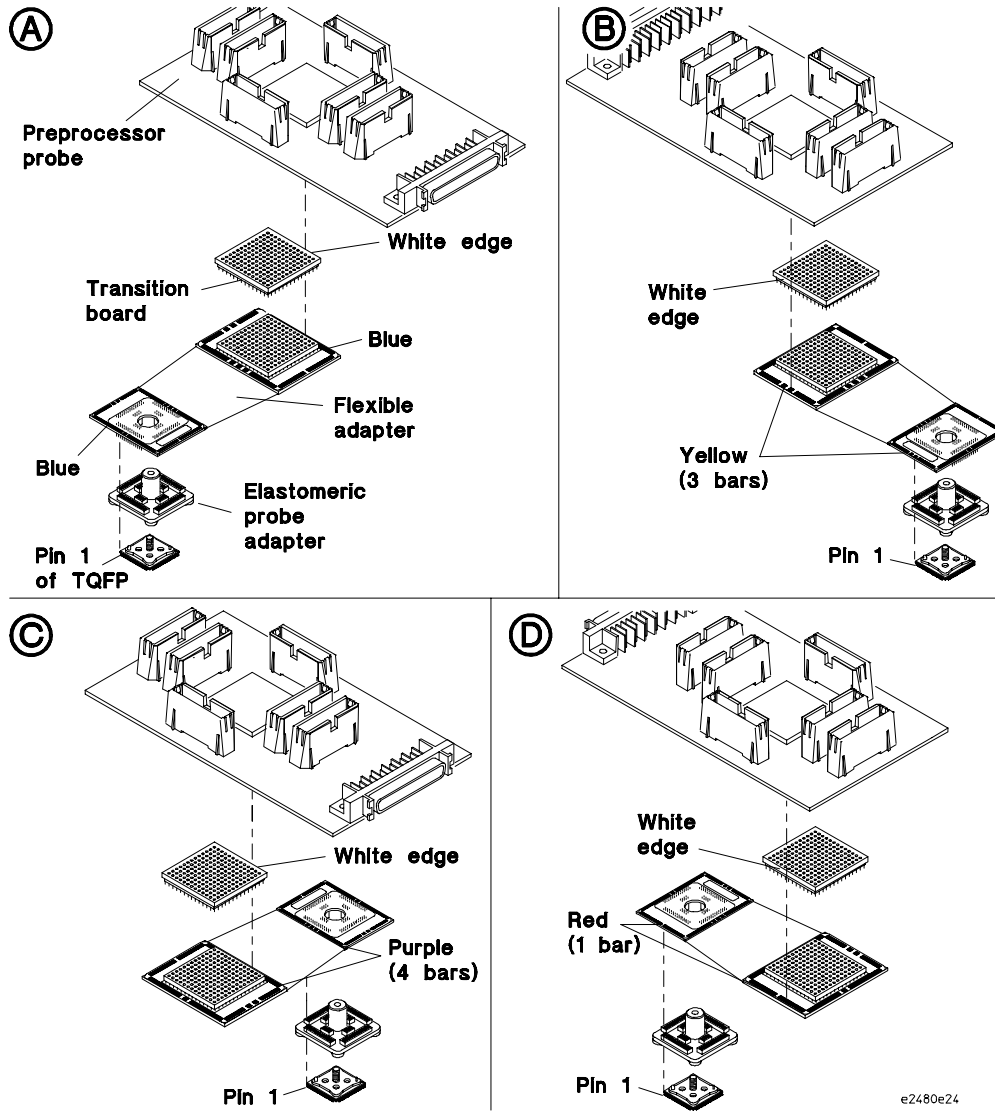

144-Pin TQFP Probing System Rotation Diagram

160-pin QFP Probe Adapter Rotations

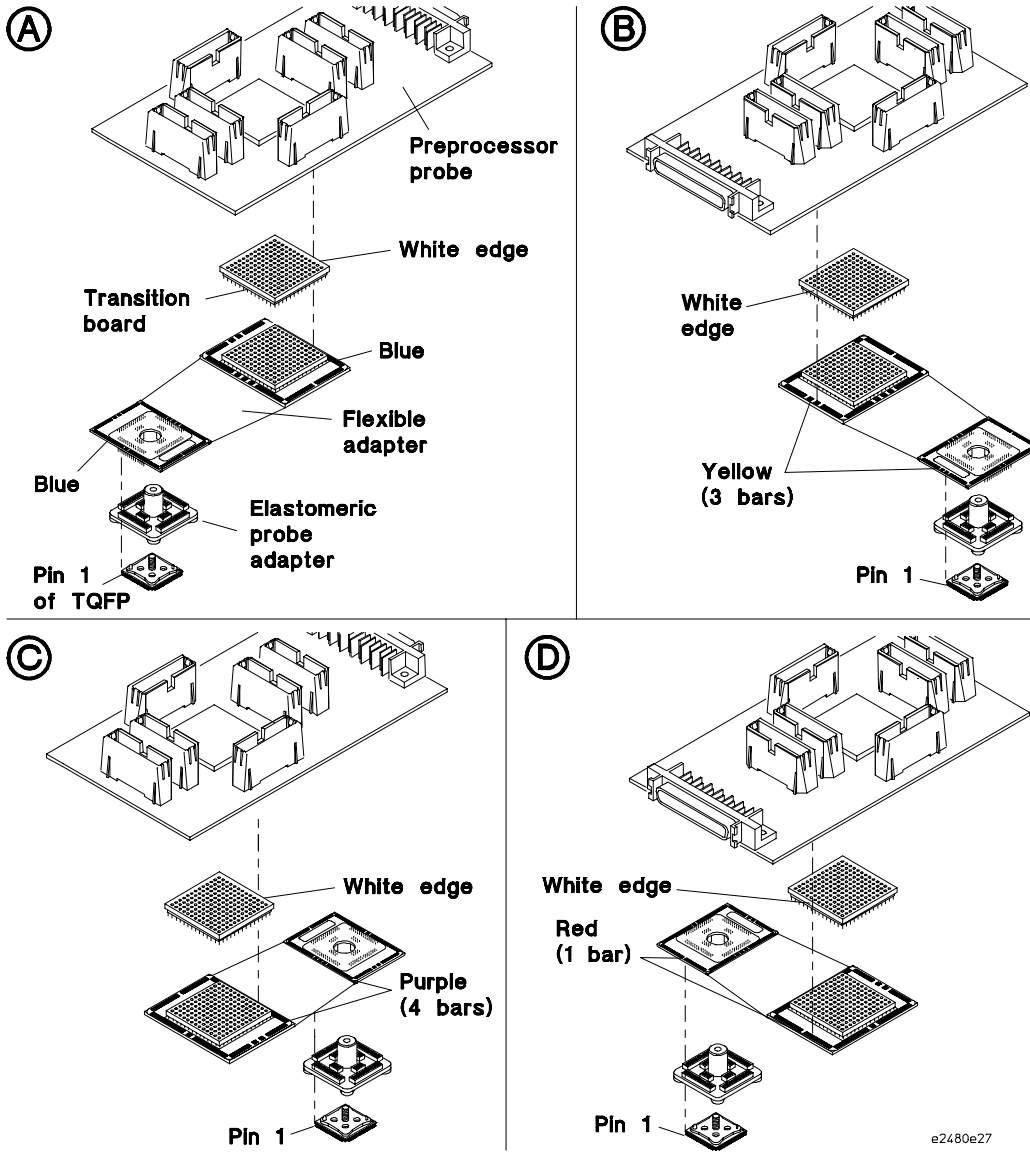

160-Pin QFP Probing System Rotation Diagram

Connecting the Preprocessor to the Logic Analyzer

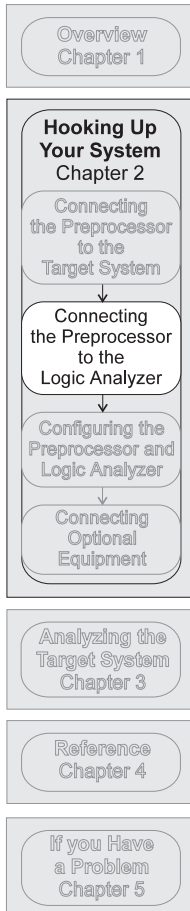

This section shows you how to connect the preprocessor to the logic analyzer. It consists of the following:

- Connecting the high-density cables to the preprocessor interface
- Connecting the high-density cables to the logic analyzer

This section shows connection diagrams that identify connections to each individual logic analyzer supported by the preprocessor interface. They are shown in the following order:

- HP 1660A/AS/C/CS logic analyzers
- HP 1661A/AS/C/CS logic analyzers
- HP 1662A/AS/C/CS logic analyzers
- HP 1670A/D logic analyzers
- HP 1671A/D logic analyzers
- HP 1672A/D logic analyzers
- One-card HP 16550A analyzer
- Two-card HP 16550A analyzer
- HP 16554A/55A/56A (one-card)
- HP 16554A/55A/56A (two-card)

Number of Pods Used/Required

The type of measurement to be made determines the number of logic analyzer pods to be used. State measurements require four pods. Full timing measurements require eight pods. If fewer than eight pods are available for timing, the logic analyzer will truncate the pods allocated. In this case, viewing the logic analyzer FORMAT menu shows the pod allocations. If the allocations will not acquire the desired signals, the allocations can be altered manually.

Connecting the High-density Cables to the Preprocessor Interface

Four high-density cables, and labels to identify them, are included with the HP E81xxA. The labels can be attached to the cables after the cables have been connected to the preprocessor interface and logic analyzer. Connect the cables to the connectors on the preprocessor interface as shown in the illustration below. Note that J1 and J6 are State connectors, and J2 through J5 are Timing connectors.

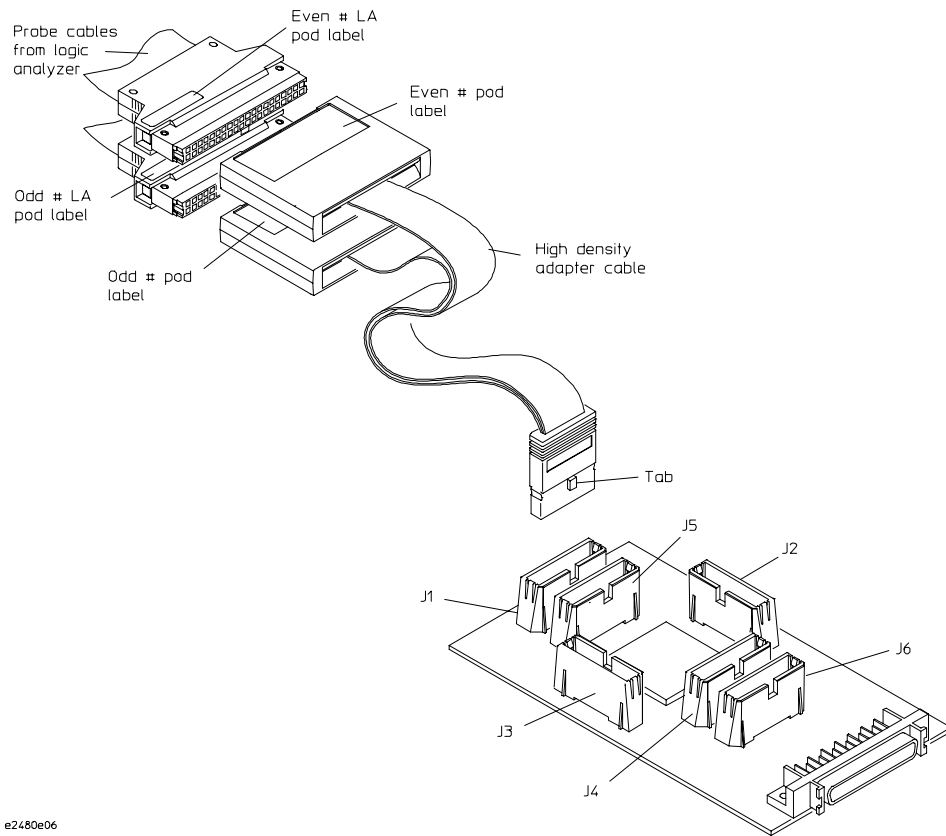

Connecting the High-density Cables to the Preprocessor Interface

Connecting the High-Density Cables to the Logic Analyzer

The following pages show the connections between the logic analyzer pod cables and the high-density cables of the preprocessor interface. Note that for each logic analyzer, there are separate connections for State and Timing. Refer to the appropriate pages for your logic analyzer. The configuration file names for each logic analyzer and each CPU32 target system are included with the connection diagrams.

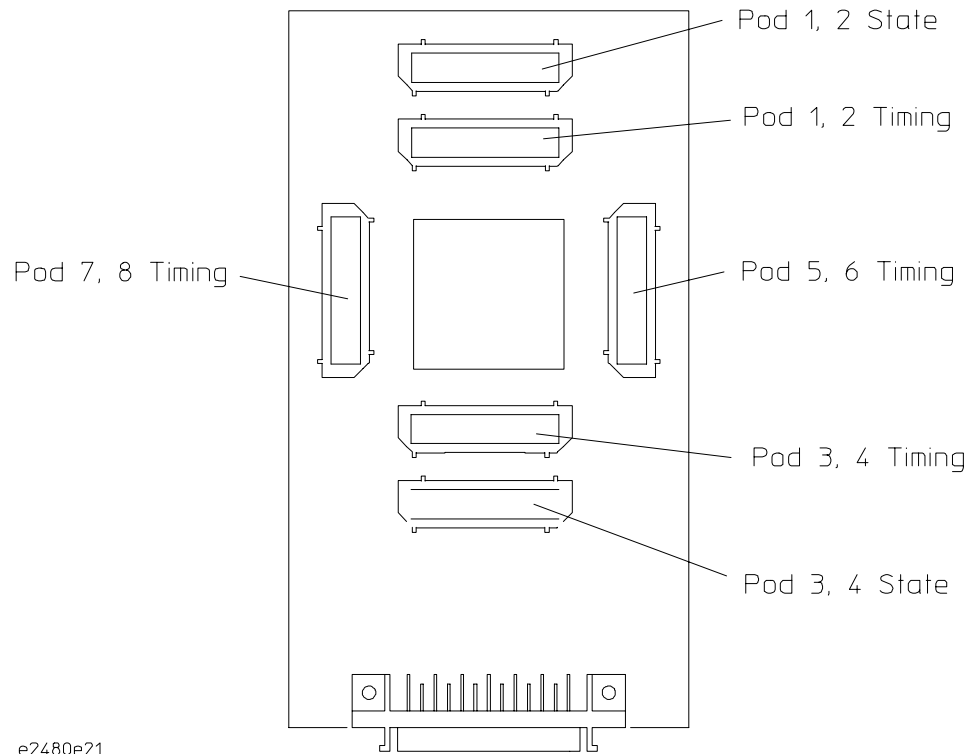

To connect to the HP 1660A/AS/C/CS logic analyzers

Use the following two figures to connect the preprocessor to the HP 1660A/C logic analyzers. Find the labels that were shipped with the high-density cables and use them to help identify the connections.

State

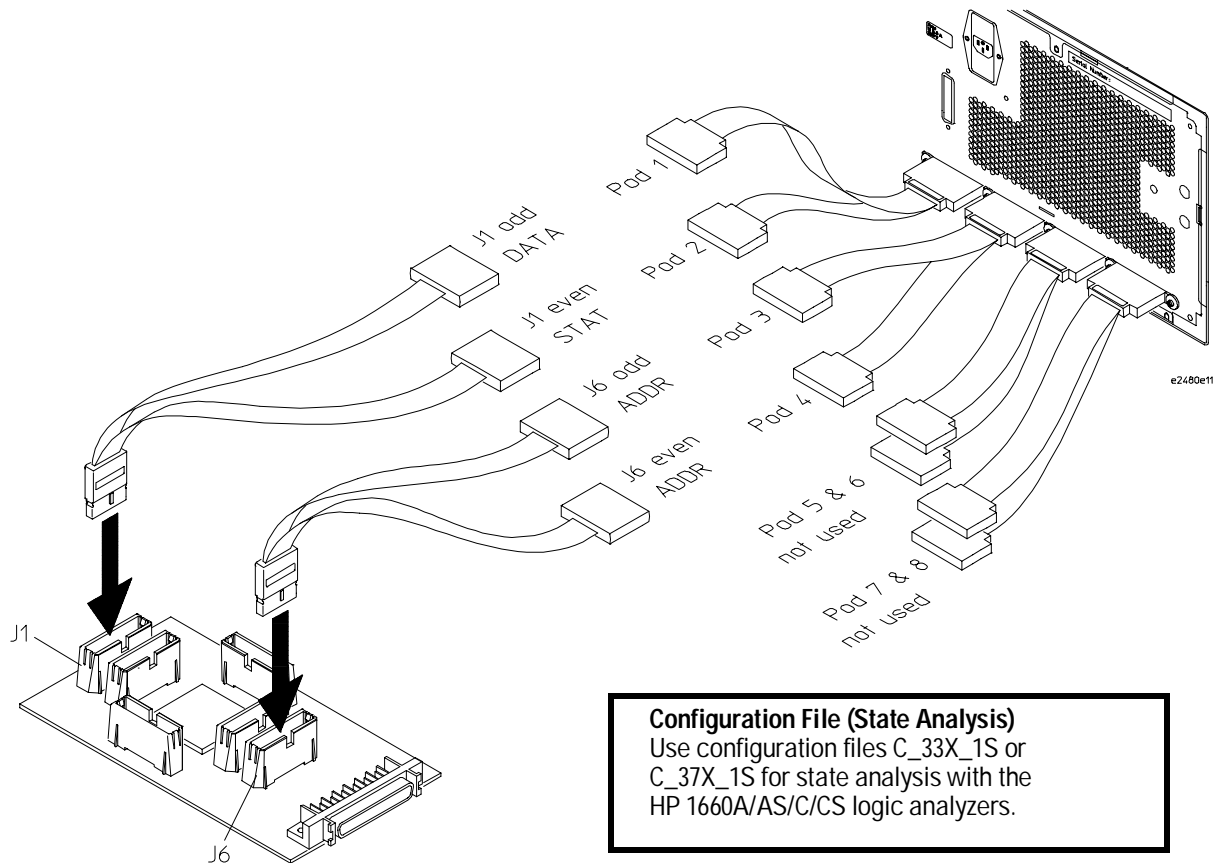

If fewer than eight pods are available for timing, the logic analyzer will truncate the pods allocated. In this case, viewing the logic analyzer FORMAT menu shows the pod allocations. If the allocations will not acquire the desired signals, the allocations can be altered manually.

Timing

Configuration File (Timing)
Use configuration file C_33X_1T or C_37X_1T for Timing analysis with the HP 1660A/AS/C/CS logic analyzers.

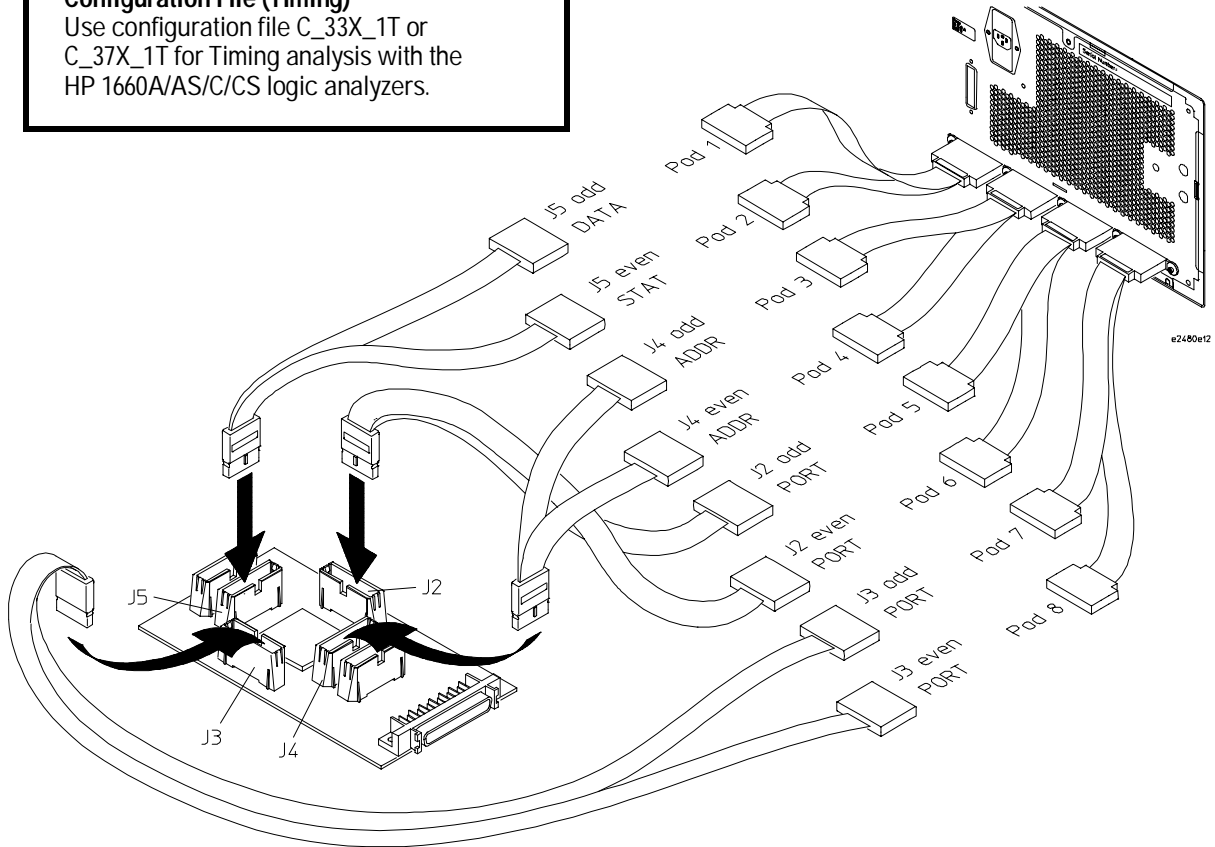

To connect to the HP 1661A/AS/C/CS logic analyzers

Use the following two figures to connect the preprocessor to the HP 1661A/C logic analyzers. Find the labels that were shipped with the high-density cables and use them to help identify the connections.

State

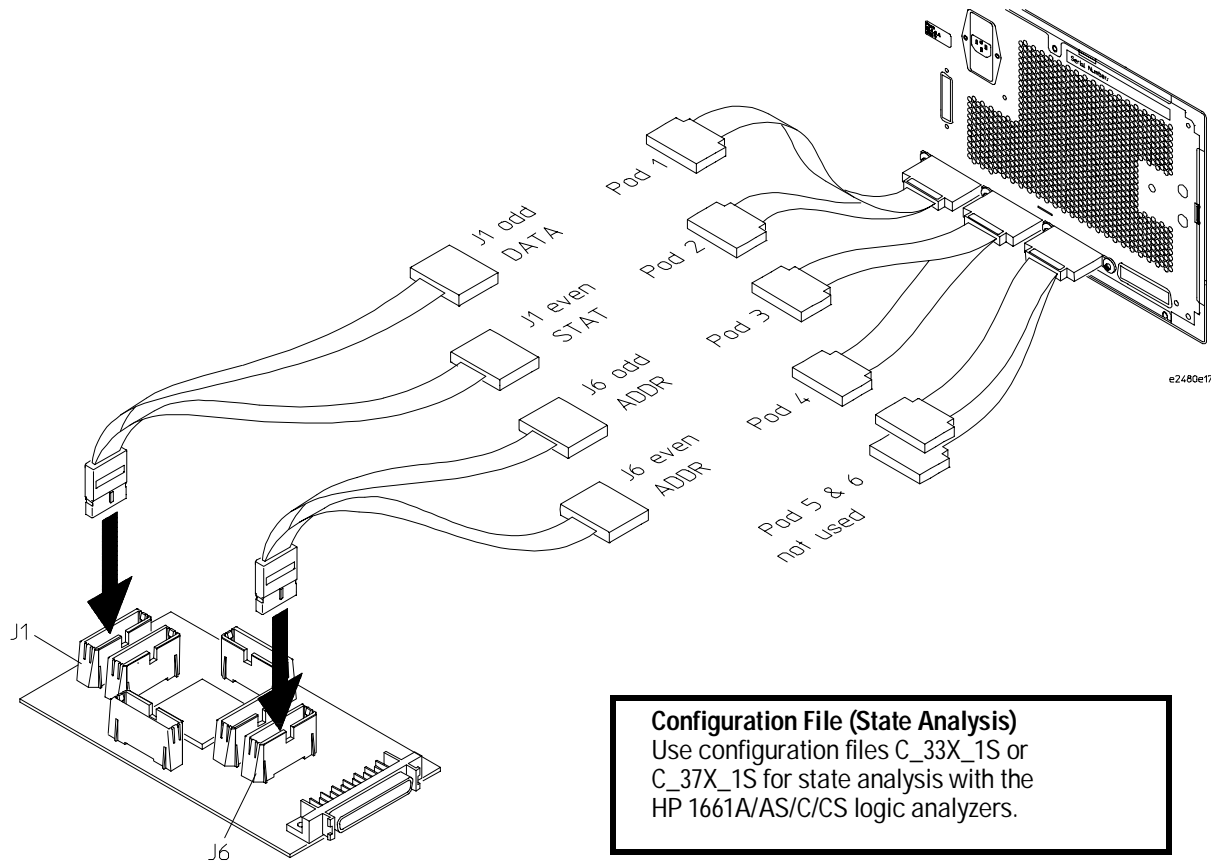

If fewer than eight pods are available for timing, the logic analyzer will truncate the pods allocated. In this case, viewing the logic analyzer FORMAT menu shows the pod allocations. If the allocations will not acquire the desired signals, the allocations can be altered manually.

Timing

Configuration File (Timing)

Use configuration file C_33X_1T or C_37X_1T for Timing analysis with the HP 1661A/AS/C/CS logic analyzers.

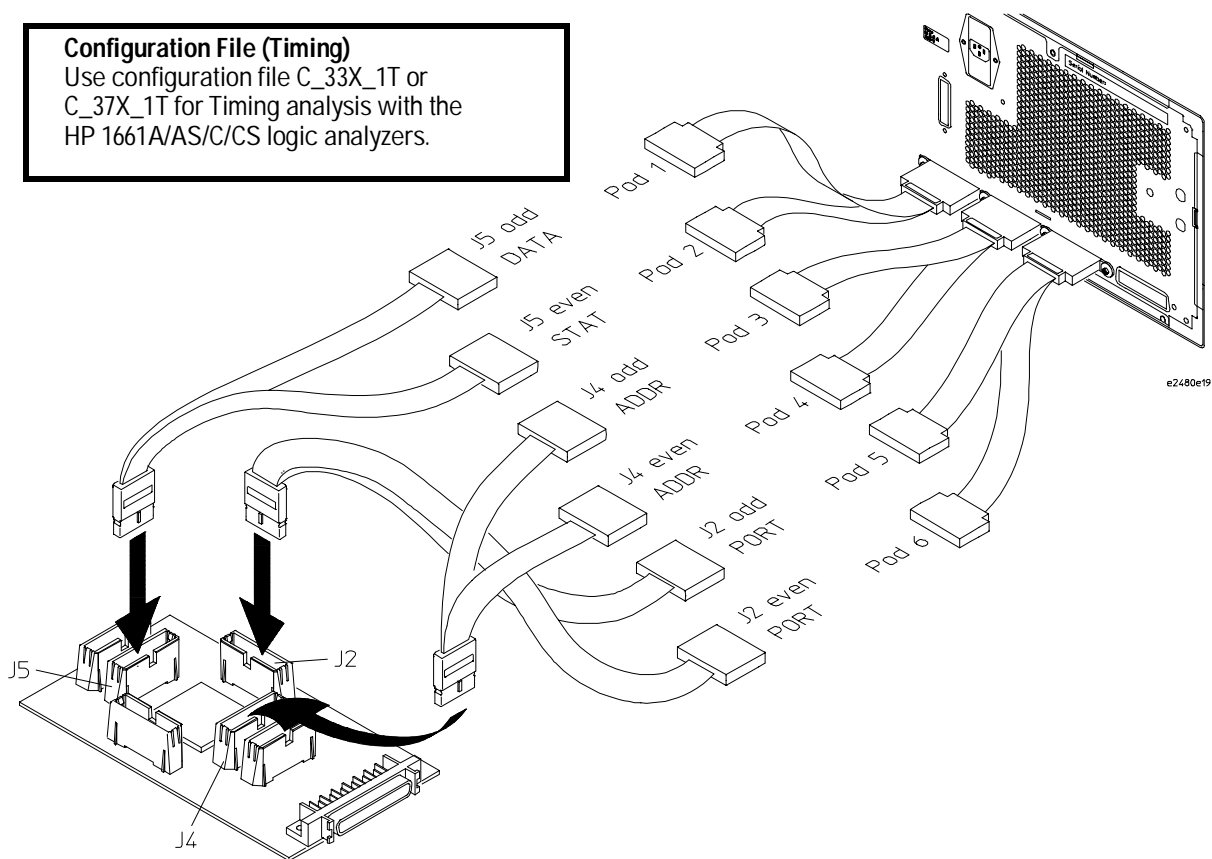

To connect to the HP 1662A/AS/C/CS logic analyzers

Use the following two figures to connect the preprocessor to the HP 1662A/C logic analyzers. Find the labels that were shipped with the high-density cables and use them to help identify the connections.

State

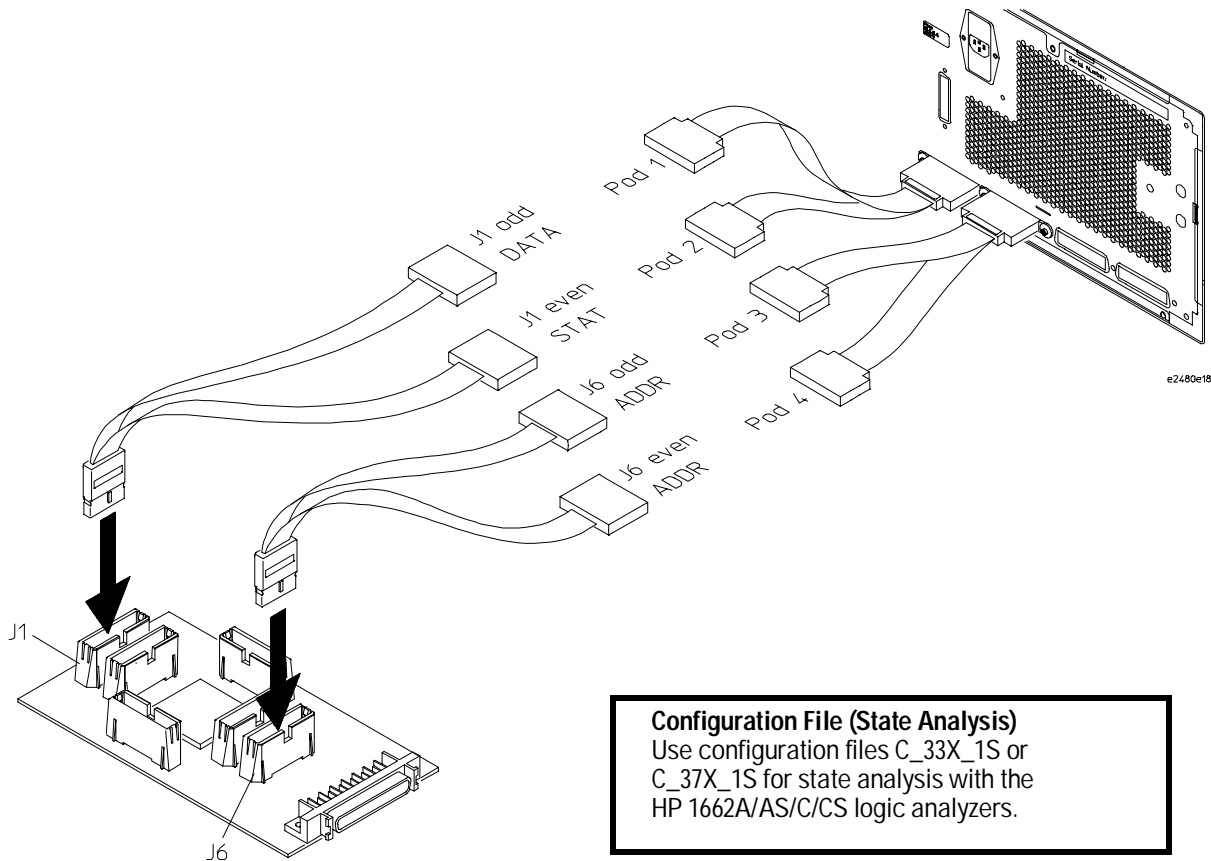

If fewer than eight pods are available for timing, the logic analyzer will truncate the pods allocated. In this case, viewing the logic analyzer FORMAT menu shows the pod allocations. If the allocations will not acquire the desired signals, the allocations can be altered manually.

Timing

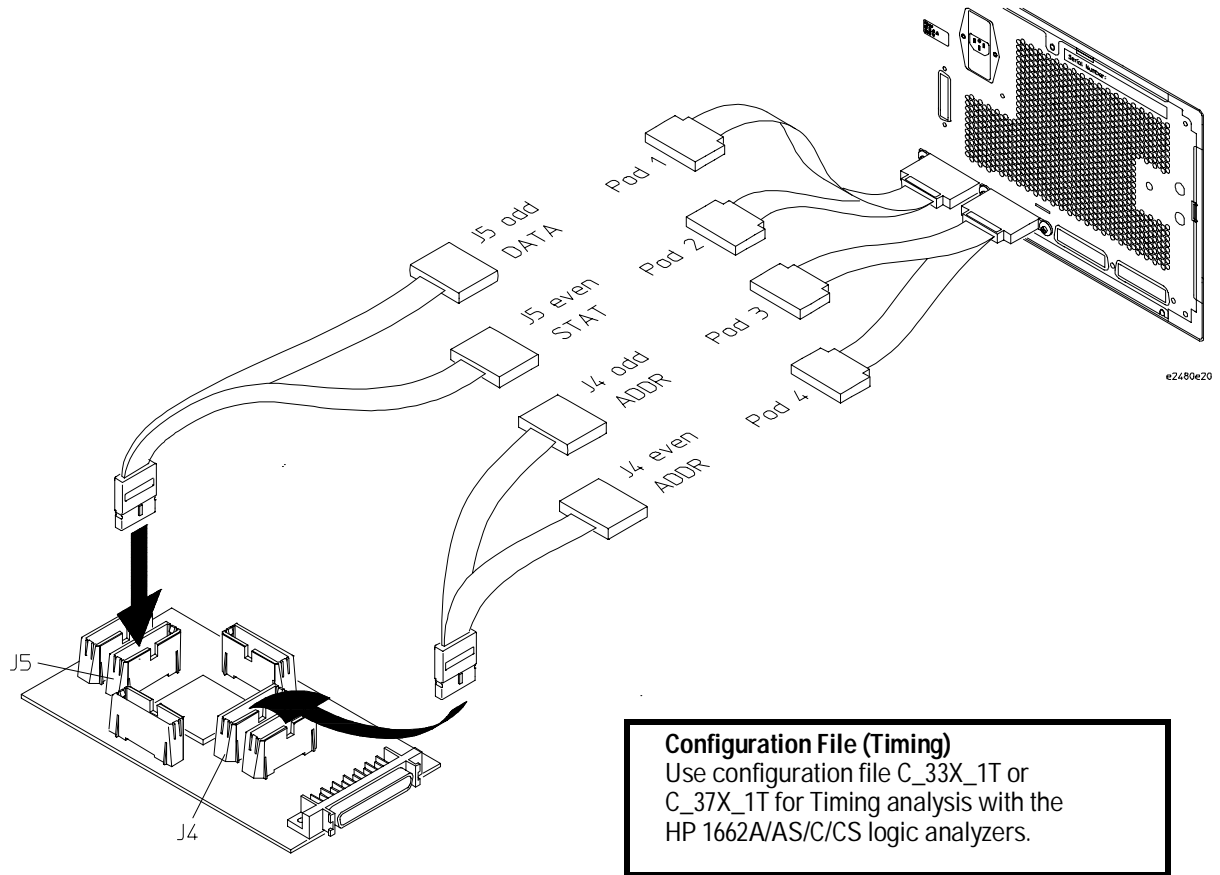

To connect to the HP 1670A/D logic analyzer

Use the figure below to connect the preprocessor to the HP 1670A/D logic analyzers. Find the labels that were shipped with the high-density cables and use them to help identify the connections.

State

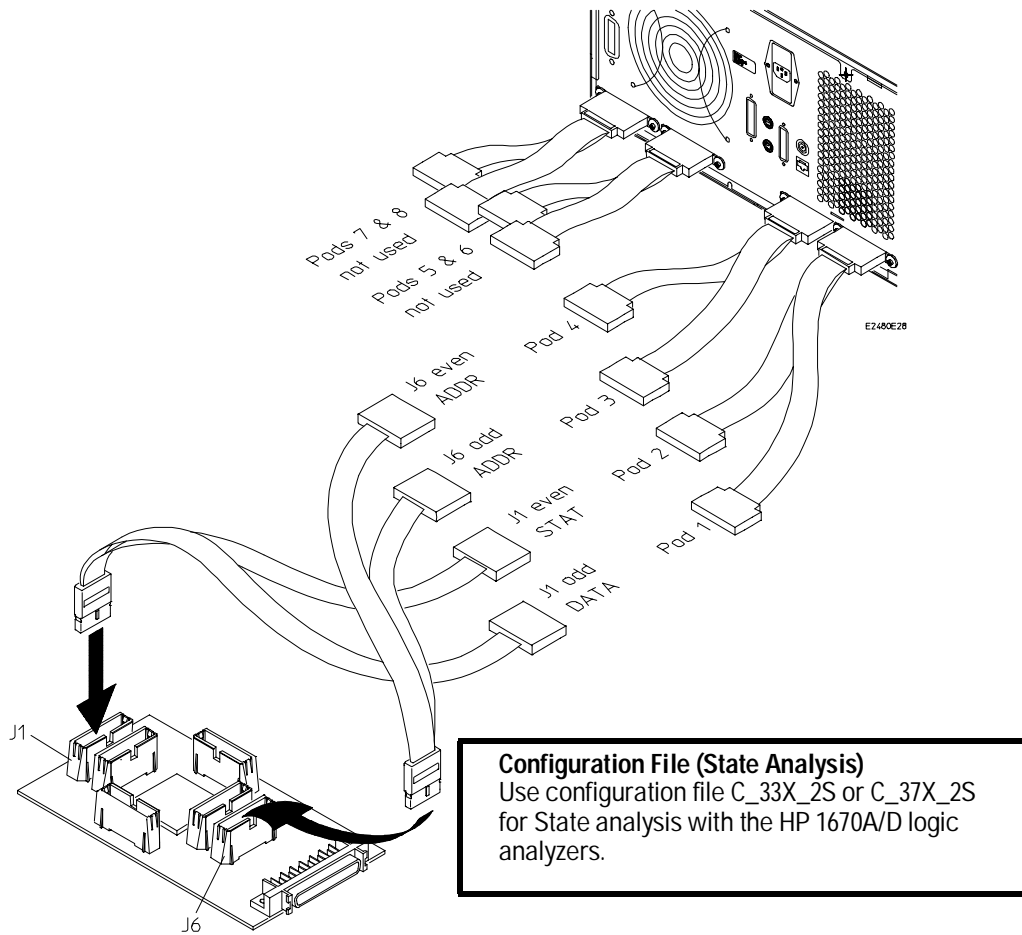

If fewer than eight pods are available for timing, the logic analyzer will truncate the pods allocated. In this case, viewing the logic analyzer FORMAT menu shows the pod allocations. If the allocations will not acquire the desired signals, the allocations can be altered manually.

Timing

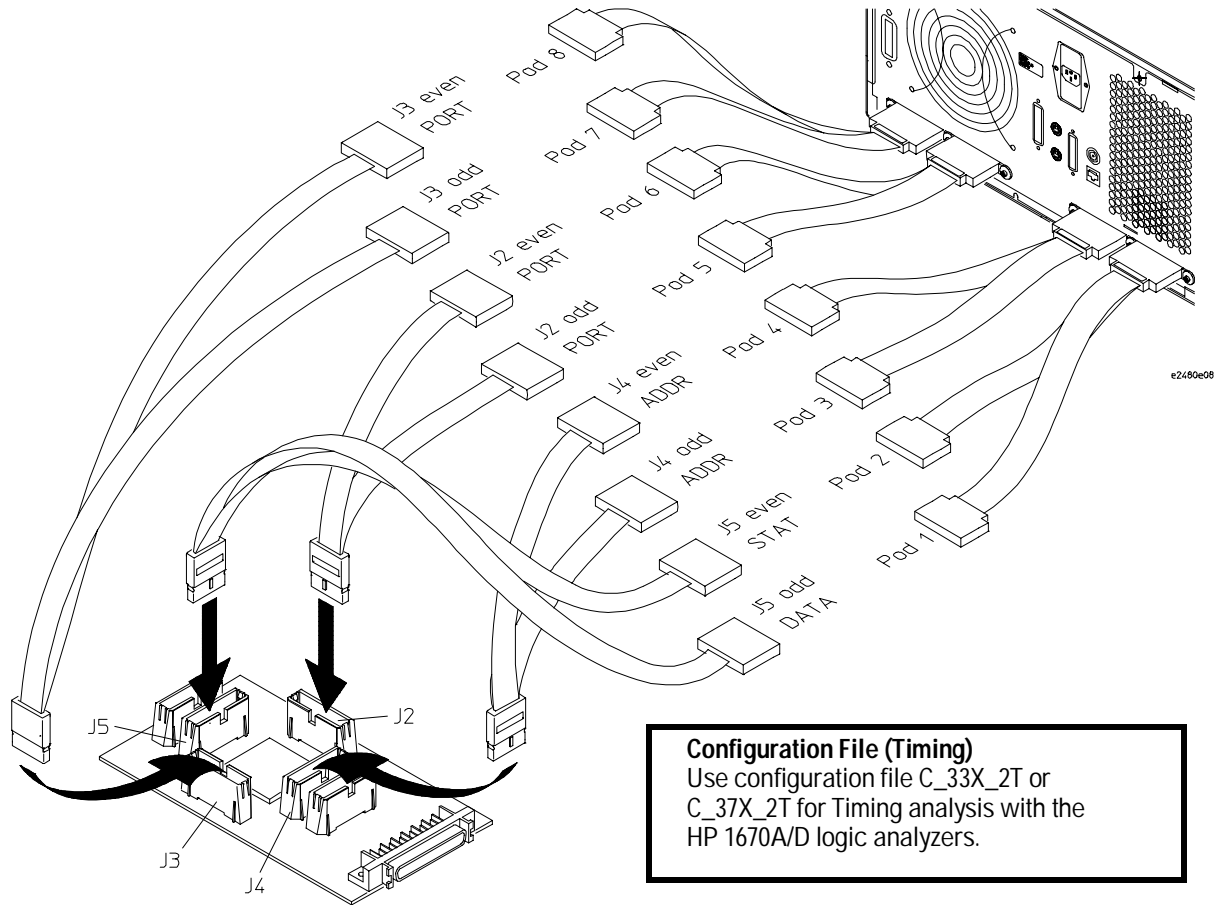

To connect to the HP 1671A/D logic analyzer

Use the figure below to connect the preprocessor to the HP 1671A/D logic analyzers. Find the labels that were shipped with the high-density cables and use them to help identify the connections.

State

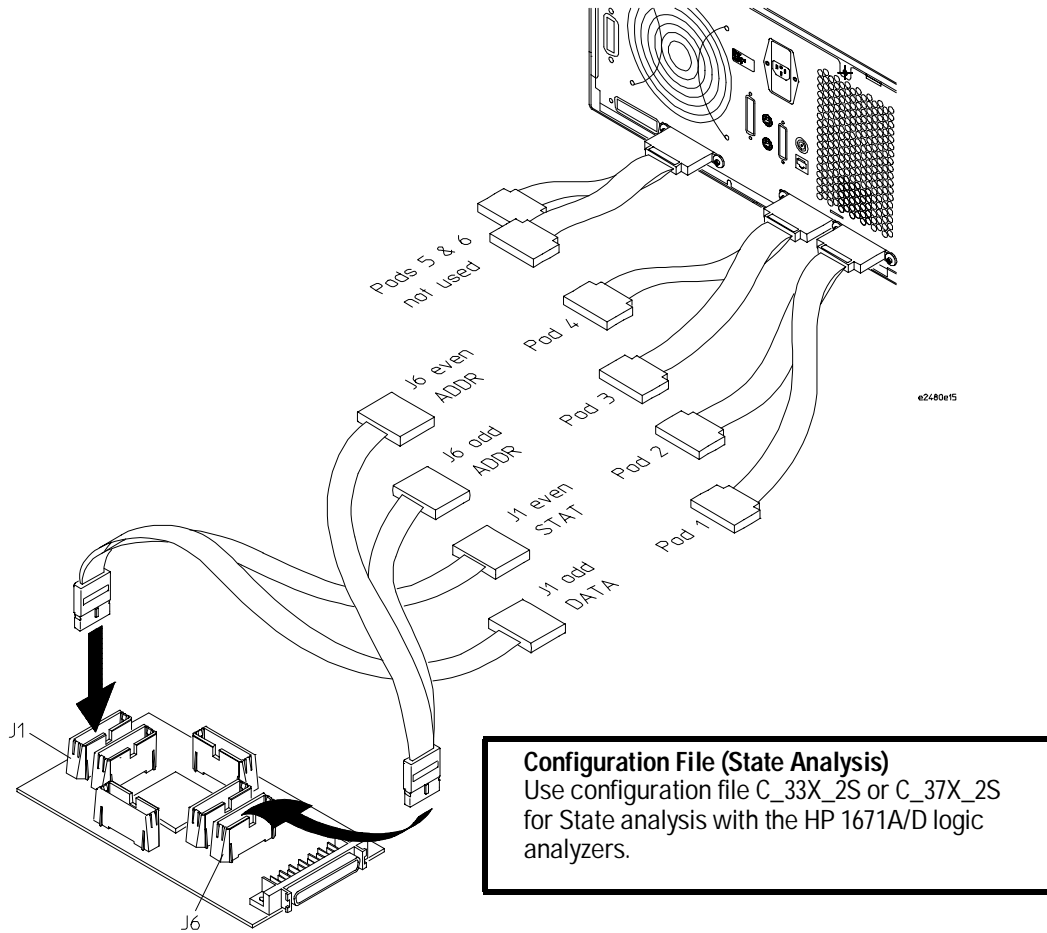

If fewer than eight pods are available for timing, the logic analyzer will truncate the pods allocated. In this case, viewing the logic analyzer FORMAT menu shows the pod allocations. If the allocations will not acquire the desired signals, the allocations can be altered manually.

Timing

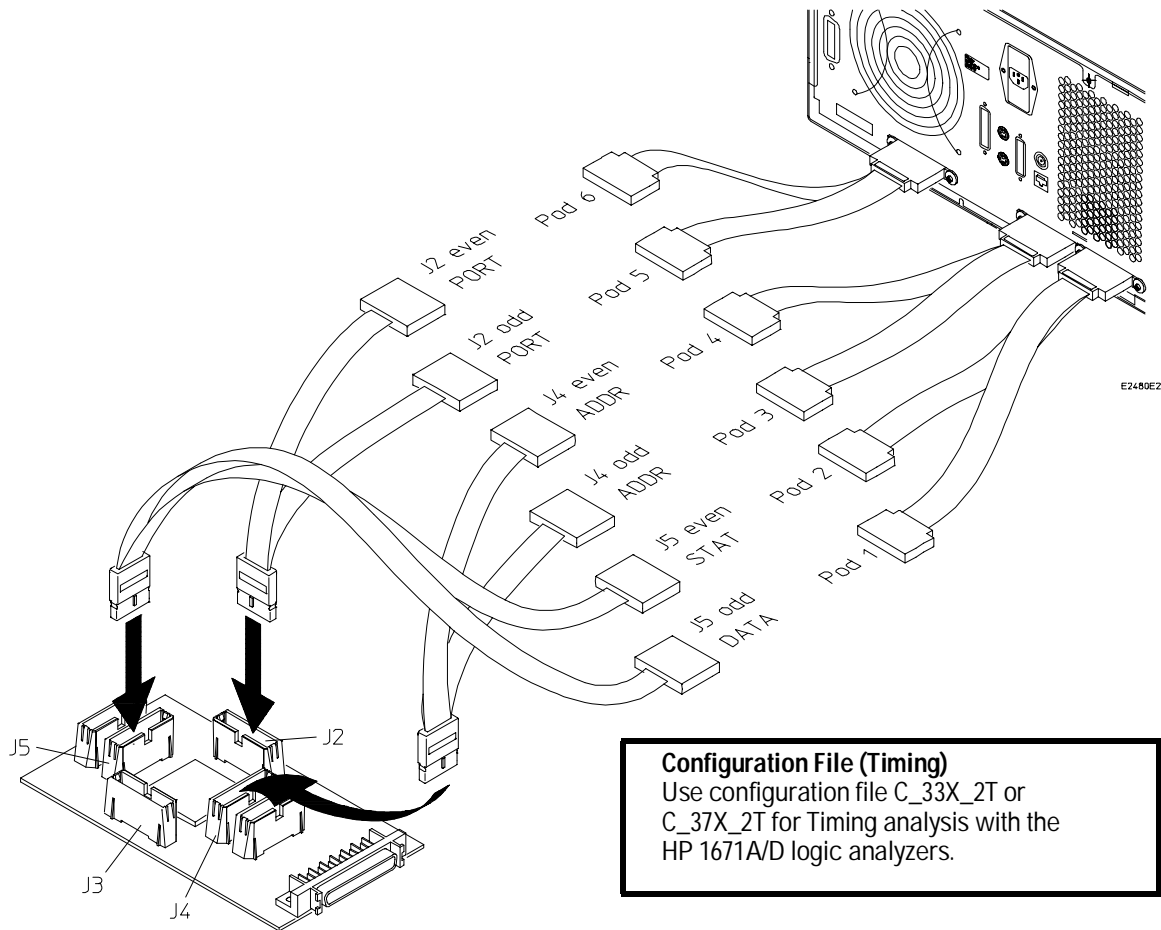

To connect to the HP 1672A/D logic analyzer

Use the figure below to connect the preprocessor to the HP 1672A/D logic analyzers. Find the labels that were shipped with the high-density cables and use them to help identify the connections.

State

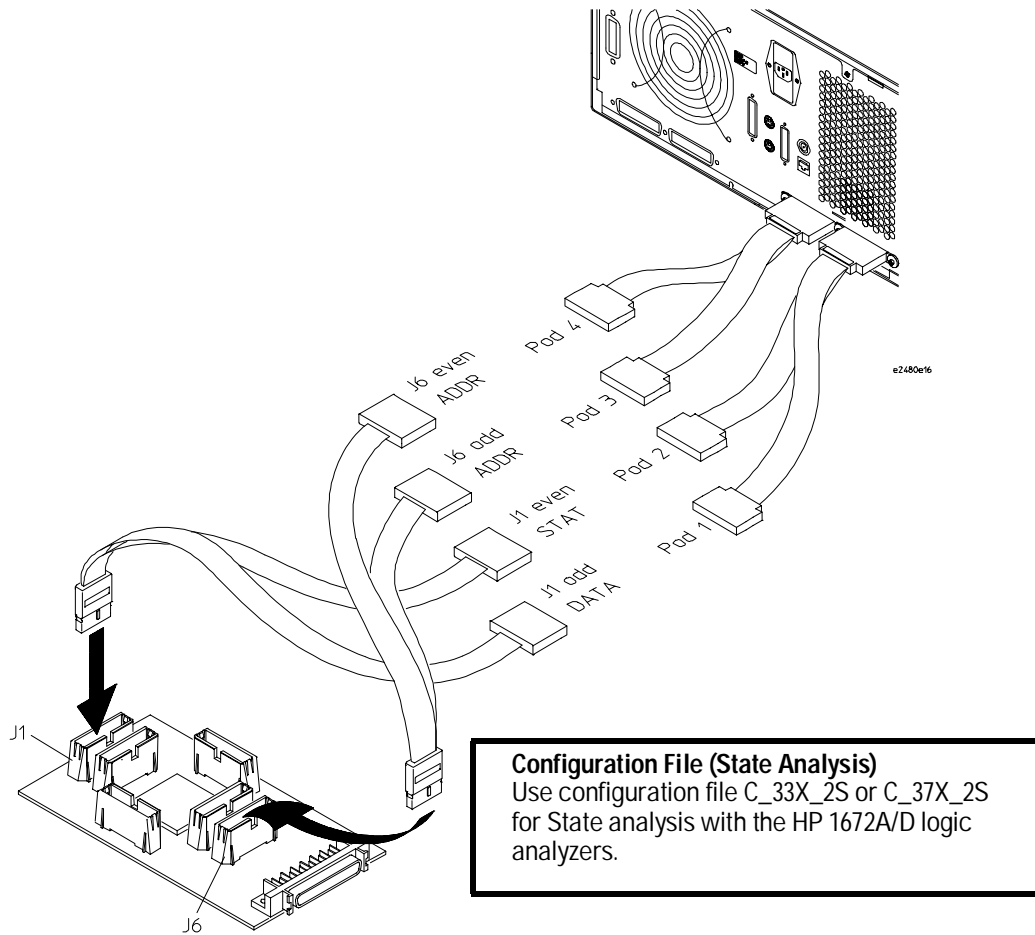

If fewer than eight pods are available for timing, the logic analyzer will truncate the pods allocated. In this case, viewing the logic analyzer FORMAT menu shows the pod allocations. If the allocations will not acquire the desired signals, the allocations can be altered manually.

Timing

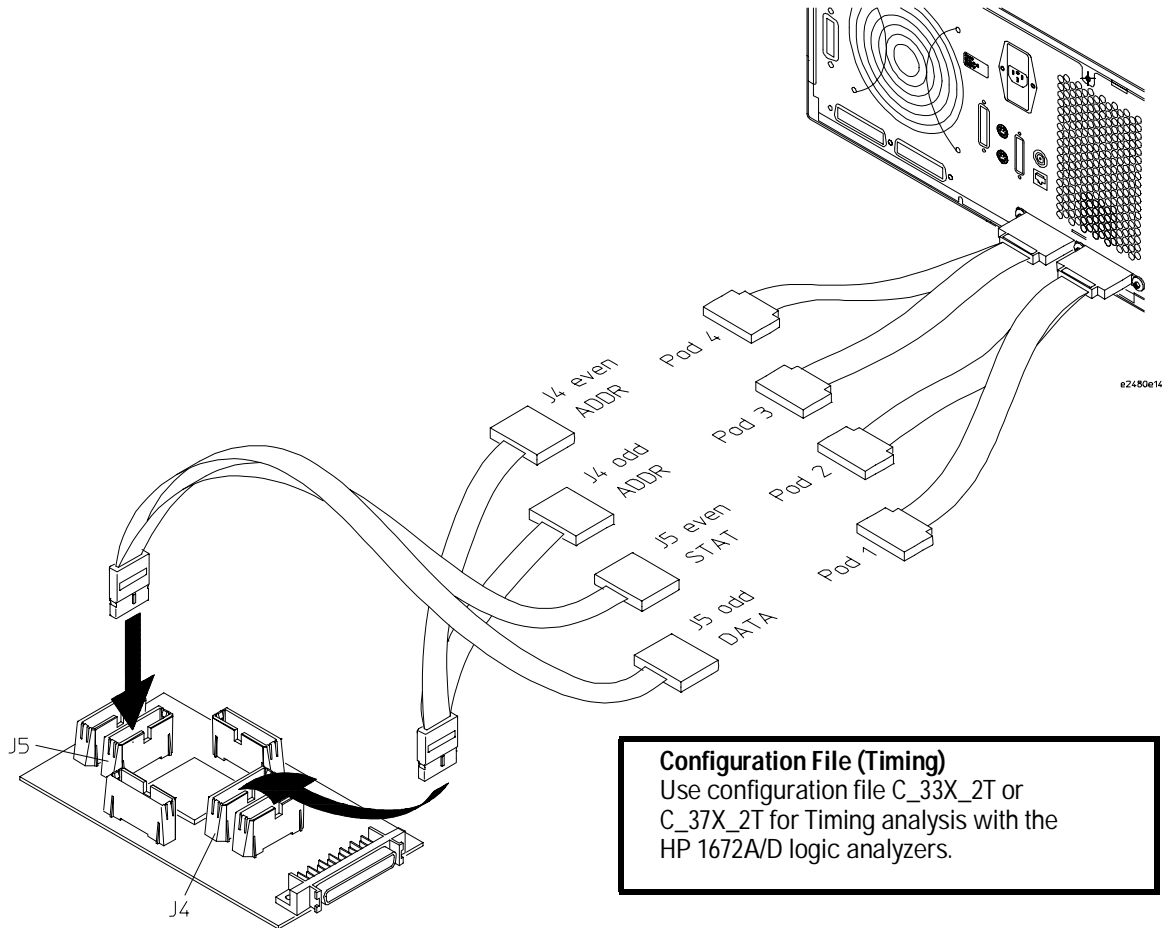

To connect to the HP 16550A logic analyzer

Use the figure below to connect the preprocessor to the HP 16550A logic analyzers. Find the labels that were shipped with the high-density cables and use them to help identify the connections.

State

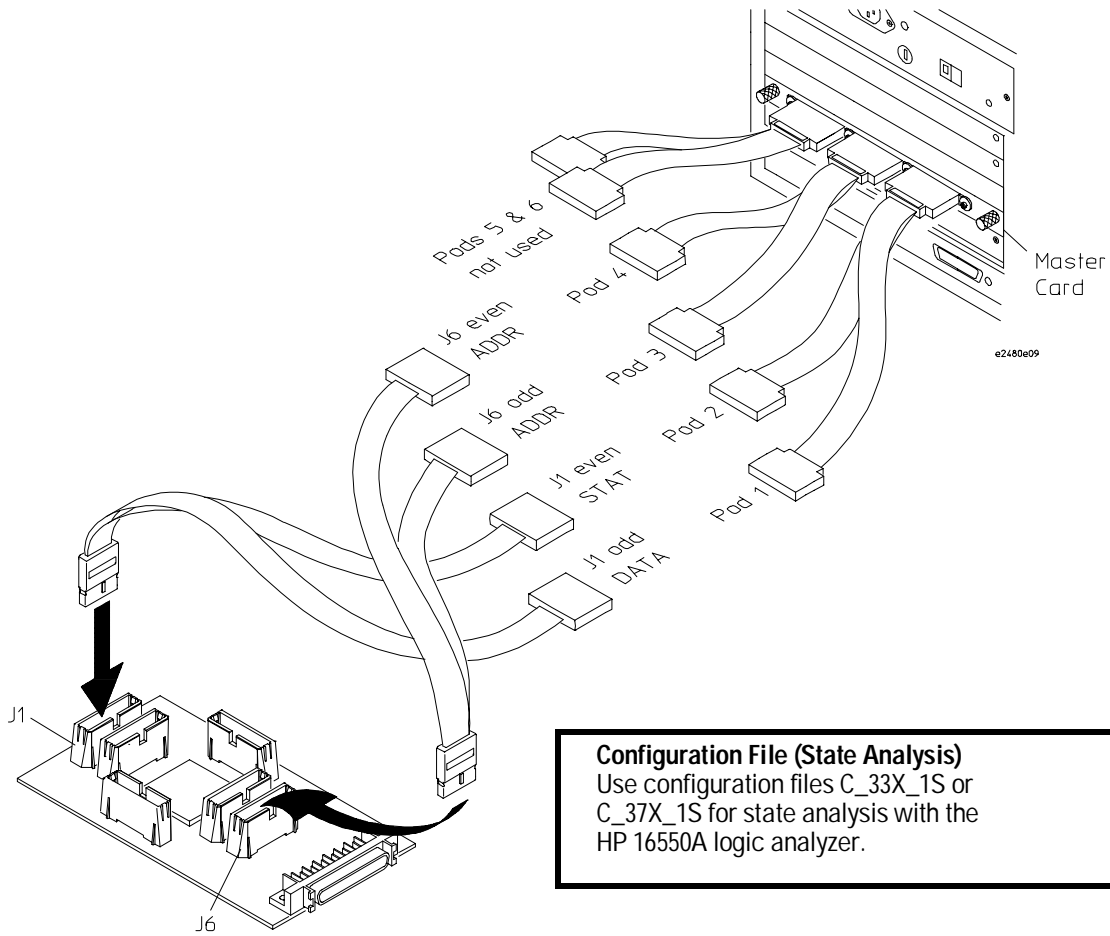

If fewer than eight pods are available for timing, the logic analyzer will truncate the pods allocated. In this case, viewing the logic analyzer FORMAT menu shows the pod allocations. If the allocations will not acquire the desired signals, the allocations can be altered manually.

Timing (one card)

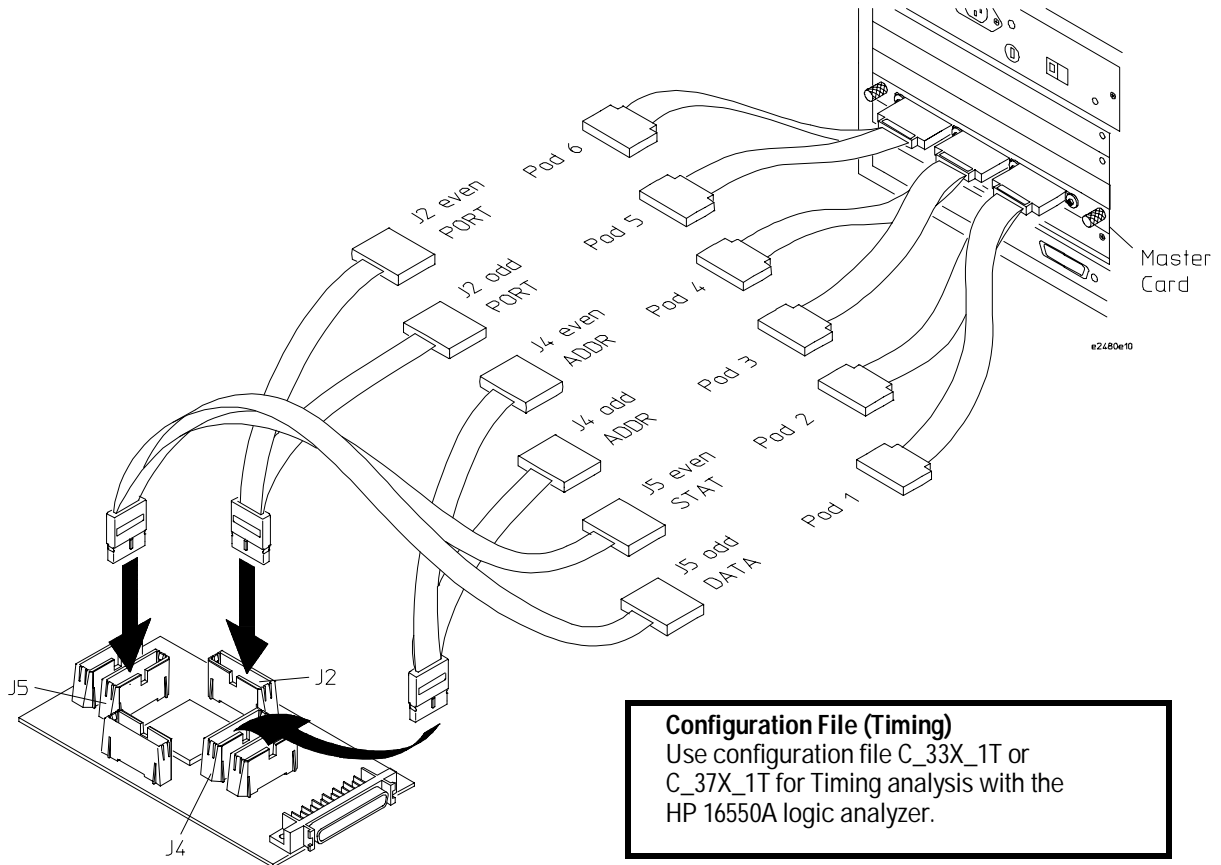

Timing (two card)

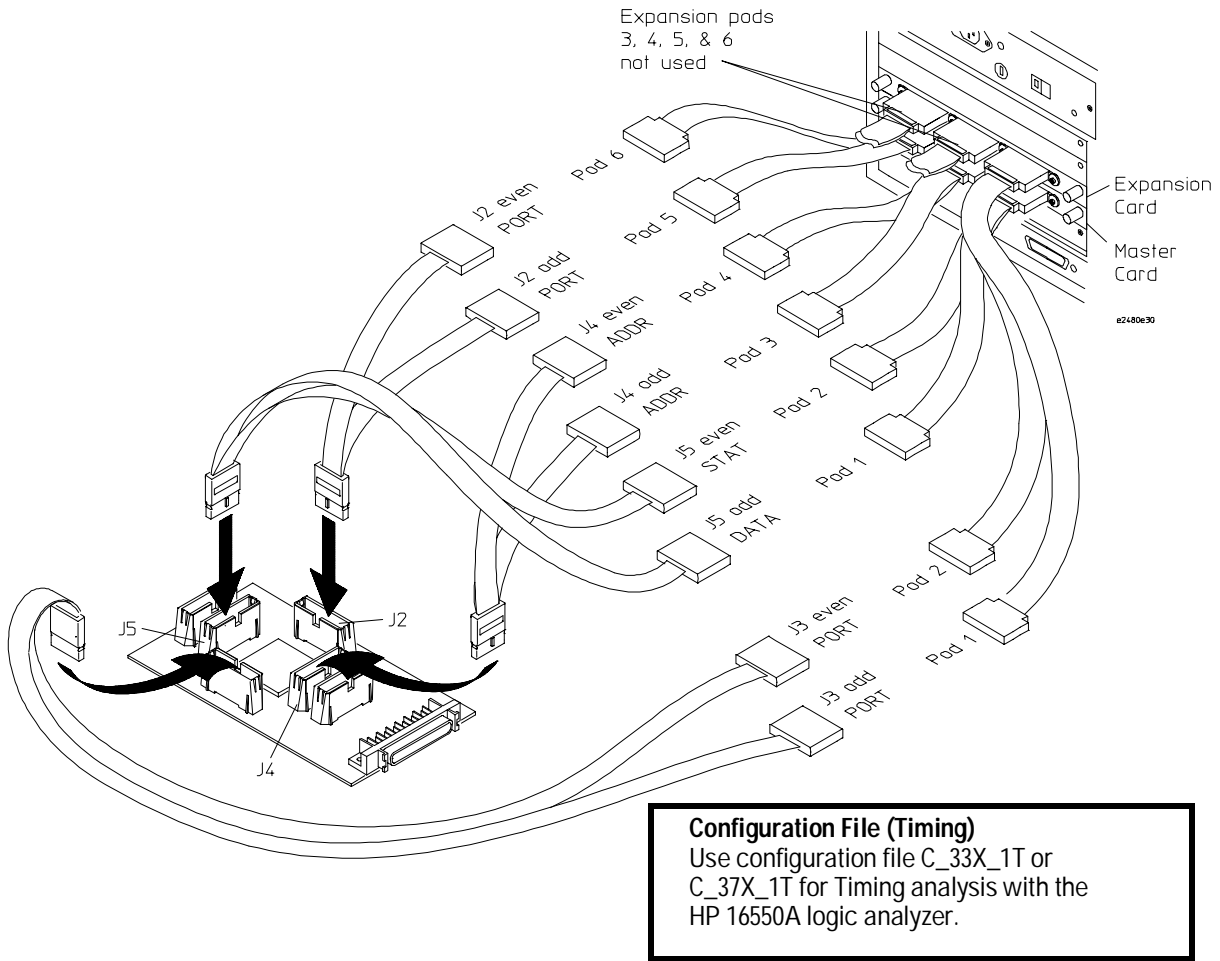

To connect to the HP 16554/55/56 logic analyzers

Use the following two figure below to connect the preprocessor to the HP 16554A/55A/56A and HP 16555D/56D logic analyzers. Find the labels that were shipped with the high-density cables and use them to help identify the connections.

State

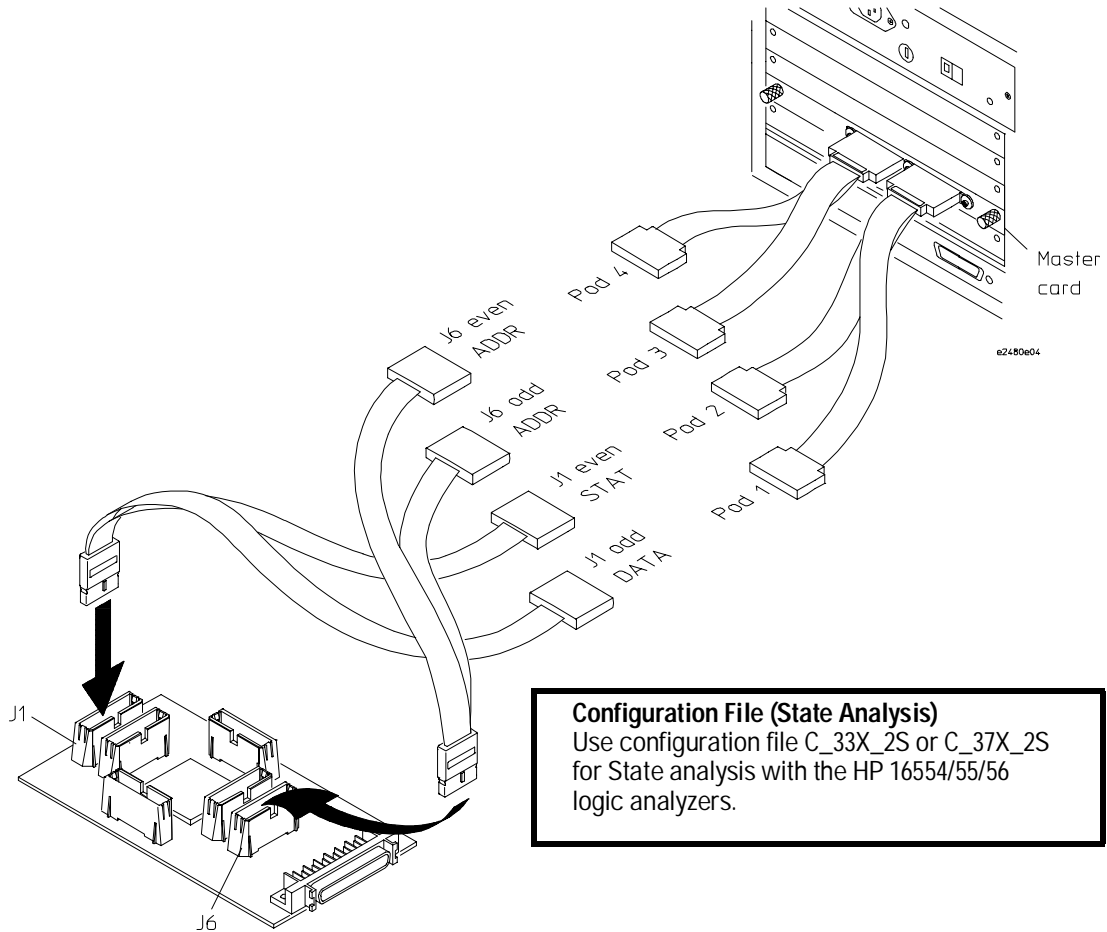

If fewer than eight pods are available for timing, the logic analyzer will truncate the pods allocated. In this case, viewing the logic analyzer FORMAT menu shows the pod allocations. If the allocations will not acquire the desired signals, the allocations can be altered manually.

Timing (One or Two Card)

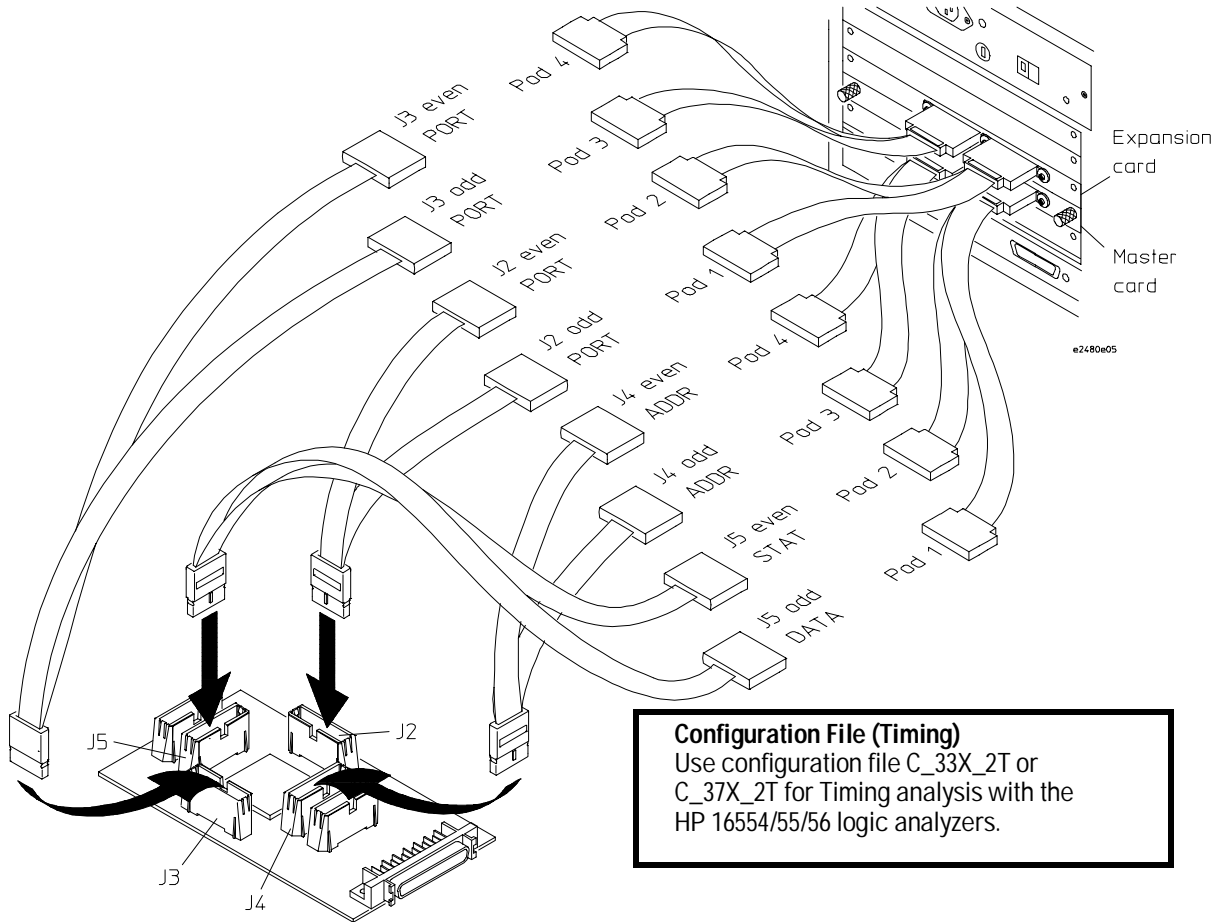

Configuring the Preprocessor and Logic Analyzer

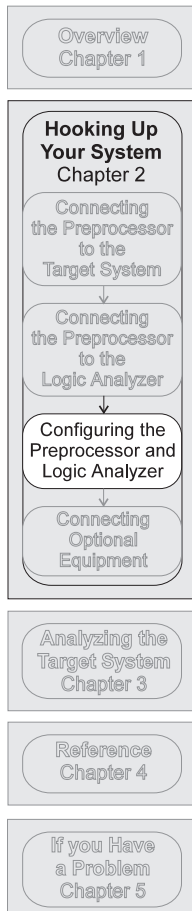

This section shows you how to configure the preprocessor and logic analyzer. It consists of the following steps:

- Configuring the preprocessor interface
- Configuring the logic analyzer

The functionality of the preprocessor and logic analyzer, and the accuracy of displays provided by the inverse assembler, depend on the address-reconstruction feature of the preprocessor. For a description of address reconstruction and its relationship to logic analyzer functionality, refer to "Address-Reconstruction Overview" in Chapter 4, Reference. This will give you a better understanding of reconstruction functionality of the preprocessor.

Configuring the preprocessor interface

Configuring the preprocessor interface consists of the following:

- Setting the ID switches
- Interpreting the LEDs
- Downloading a configuration

To set the ID switches

The HP E2480A provides an identification (ID) which may be used by other system components. The ID consists of primary and secondary values. The primary value is fixed (identifies CPU32 family) by hardware. The secondary ID is set by the 8-bit switch on the preprocessor, which must be configured to match the microcontroller being used. Positions 1 - 7 of the switch generate a binary value which must correspond to the last two digits of the microcontroller (binary 32 for MC68332). Position 8 is reserved and should be set to the "1" position.

The figure below shows the switch settings for the MC68332.

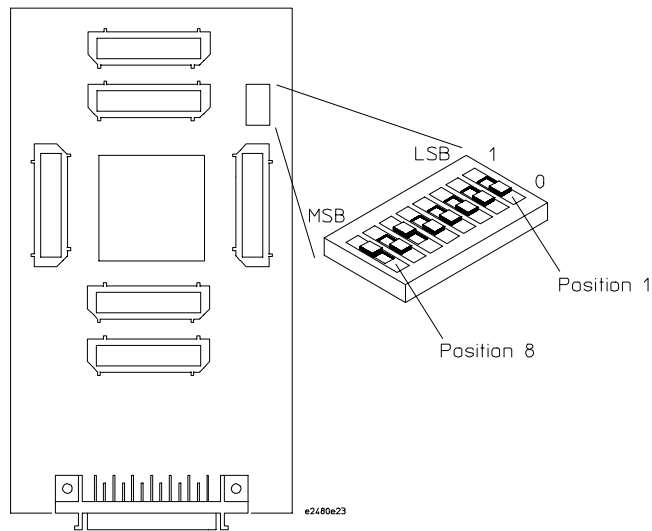

Switch Settings for MC68332 Target System

To interpret the LEDs

The LEDs on the preprocessor interface hardware have meanings described below, after the following has been done:

1. The ID switches have been set (described in previous section).
2. The preprocessor configuration has been downloaded.

LED Interpretations

- LED DS1 - Default

This LED identifies the type of configuration loaded into the reconstruction hardware. If the LED is lit, the default configuration is loaded. If this LED is not lit, a custom configuration is loaded. This LED only has meaning if LED DS2 is not lit.

- LED DS2 - NO CONFIG

This LED indicates whether or not a configuration has been loaded into the preprocessor interface. If it is lit, no configuration has been loaded. If it is not lit, a configuration has been loaded.

- LED DS3 - Reserved for future support of hardware breakpoints.

The illustration on the following page shows the HP E2480A LEDs.

If DS2 remains lit after power has been applied to the preprocessor, the preprocessor contains an unknown reconstruction configuration. To resolve this unknown state, cycle power to the preprocessor or execute a "pp load" command (see next section).

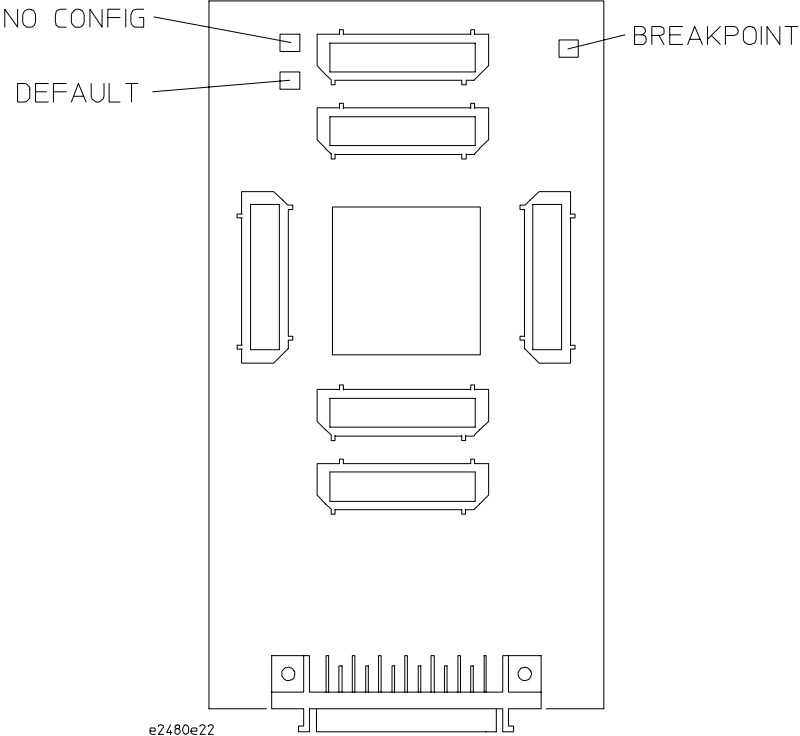

HP E2480A LED Locations

Downloading a configuration

The HP E2480A is shipped with all reconstruction disabled. This preprocessor configuration provides accurate analysis when A[19:23], FC[0:2], SIZ0, SIZ1, DSACK0, and DSAK1 are valid. If your target system is configured differently, you must configure the preprocessor to match your target system configuration.

To configure the preprocessor, the HP E2480A must be connected to an HP E3458A Processor Probe. The processor probe must be connected to a computer via LAN or RS-232-C. The HP E2480A preprocessor may be configured from either an HP approved debugger or the HP 16505A Prototype Analyzer. For a list of HP approved debugger vendors, contact your HP Sales and Service office.

Configuring With a Debugger

Using a debugger, there are two methods of configuration. The first method requires values to be manually written into SIM/SCIM registers MCR, PEPAR, CSPAR0, CSPAR1, and the CSBARx and CSORx of all chip selects being used. The second method requires code to be loaded into the target, performing a "reset" and "run", then performing a "break" after the SIM/SCIM registers have been configured. In either case, once the SIM/SCIM registers are configured, telnet to the processor probe (HP E3458A) and perform "sync sim" and "pp load". This will place information needed by the preprocessor for configuration in the preprocessor non-volatile memory.

Configuring With the HP 16505A Prototype Analyzer

Using the HP 16505A Prototype Analyzer, move the uP run control icon into the workspace, click the right mouse button and select "Start Session". A "uP run control" window should appear. In the "Processor Probe LAN Name" field, place the LAN name of the HP E3458A connected to the target of interest and click "start session".

When a connection is established, an "Information" window should appear indicating connection success. Click on "OK". Another window, "run control" should also appear. Under the "Window" pull-down menu, select "Configuration". Two windows should appear, "Configuration" and "Error/status log".

Using the "Configuration" window, there are two methods of preprocessor configuration. The first method requires values to be manually written into SIM/SCIM register fields MCR, PEPAR, CSPAR0, CSPAR1, and the CSBARx

and CSORxof all chip selects being used. The second method requires code to be loaded into the target, performing a "reset" and "run", then performing a "break" after the SIM/SCIM registers have been configured. In either case, once the "Configuration" window SIM/SCIM register fields contain the desired values, click on the "Load Preprocessor" button. This will place information needed by the preprocessor for configuration in the preprocessor non-volatile memory.

Configuring the Logic Analyzer

Configuring the logic analyzer consists of loading the software by inserting the floppy disk into the logic analyzer disk drive and loading the proper configuration file. The configuration file you use is determined by the logic analyzer you are using, and whether you are performing state analysis or timing analysis.

To load the configuration and inverse assembler

The first time you set up the preprocessor interface, make a duplicate copy of the master disk. For information on duplicating disks, refer to the reference manual for your logic analyzer.

For logic analyzers with a hard disk, you might want to create a directory such as MC68332 on the hard drive and copy the contents of the floppy onto the hard drive. You can then use the hard drive for loading files.

1 Insert the floppy disk in the front disk drive of the logic analyzer.

2 Go to the Flexible Disk menu.

3 Configure the menu to load.

4 Use the knob to select the appropriate configuration file.

Choosing the correct configuration file depends on which analyzer you are using. The configuration files are shown with the logic analyzer connection tables, and are also in the table on the next page.

5 Select the appropriate analyzer on the menu. The HP 165xx logic analyzer modules are shown in the table on the next page.

6 Execute the load operation on the menu to load the file into the logic analyzer.

The logic analyzer is configured for CPU32 analysis by loading the appropriate configuration file. Loading a state configuration file also automatically loads the inverse assembler.

7 If you are using the HP 16505A Prototype Analyzer, insert the "16505 Prototype Analyzer" flexible disk into disk drive of the prototype analyzer and update the HP 16505A from the Session Manager. You must close your workspace to run the update.

The HP 16505A Prototype Analyzer requires software version A.01.22 or higher to work with the HP E2480A.

Logic Analyzer Configuration Files

Analyzer Model	16500 Analyzer Description	State Configuration File	Timing Configuration File
16550A (one card)	100 MHz STATE 500 MHz TIMING	C_33X_1S C_37X_1S	C_33X_1T C_37X_1T
16550A (two card)	100 MHz STATE 500 MHz TIMING	C_33X_1S C_37X_1S	C_33X_1T C_37X_1T
16554A (one card)	0.5M SAMPLE 70/250 MHz LA	C_33X_2S C_37X_2S	C_33X_2T C_37X_2T
16555A/D (one card)	1.0M SAMPLE 110/250 MHz LA	C_33X_2S C_37X_2S	C_33X_2T C_37X_2T
16556A/D (one card)	1.0M SAMPLE 100/400 MHz LA	C_33X_2S C_37X_2S	C_33X_2T C_37X_2T
16554A/D (two card)	0.5M SAMPLE 70/250 MHz LA	C_33X_2S C_37X_2S	C_33X_2T C_37X_2T
16555A/D (two card)	1.0M SAMPLE 110/250 MHz LA	C_33X_2S C_37X_2S	C_33X_2T C_37X_2T
16556A/D (two card)	1.0M SAMPLE 100/400 MHz LA	C_33X_2S C_37X_2S	C_33X_2T C_37X_2T
1660A/AS/C/CS, 1661A/AS/C/CS, 1662A/AS/C/CS		C_33X_1S C_37X_1S	C_33X_1T C_37X_1T
1670A/D, 1671A/D, 1672A/D		C_33X_2S C_37X_2S	C_33X_2T C_37X_2T

Connecting Optional Equipment

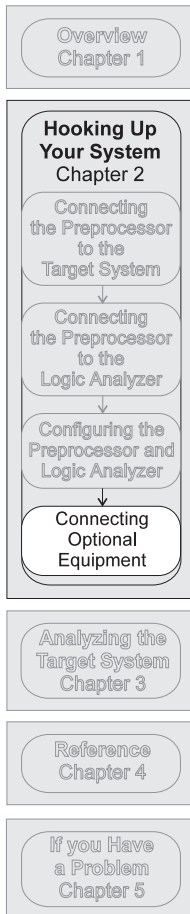

The remaining portion of this chapter shows you how to connect optional equipment you may wish to use to obtain additional functionality. At the time this manual was printed, the following optional equipment was available for use with the preprocessor interface:

- HP E3458A Processor Probe
- HP 16505A Prototype Analyzer

To connect the HP E3458A Processor Probe

The processor probe allows you to halt execution, download code (if the target is RAM based), read/write memory and registers, and step through software. The HP E3458A also provides a connector to source-level debuggers, which are available from a number of vendors. Refer to the HP E3458A Data Sheet for a list of supported debuggers.

To connect the processor probe to the preprocessor interface, use the following procedure.

- 1 Turn off power.** Refer to Power-On/Power-Off Sequence in Chapter 1.
 - 2 Connect the 50-pin cable to the processor probe.** Then connect the other end of the cable to the 50-pin connector on the preprocessor interface. The connectors are keyed.
 - 3 Turn on power.** Refer to Power-On/Power-Off Sequence in Chapter 1.
-

To connect the HP 16505A Prototype Analyzer

Refer to the *HP E3458A Processor Probe User's Guide* for instructions on connecting to the HP 16505A Prototype Analyzer.

Analyzing the Target System

Analyzing the Target System

This chapter describes modes of operation for the HP E2480A Preprocessor Interface. It also describes preprocessor interface data, symbol encodings, and information about the inverse assembler.

The information in this chapter is presented in the following sections:

- Modes of operation
- Format menu
- Using the inverse assembler

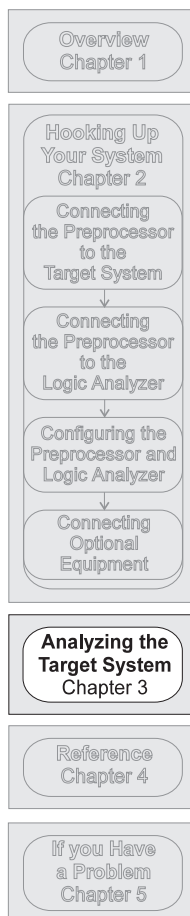

Modes of Operation

The HP E2480A Preprocessor Interface can be used in State mode or Timing mode. The following sections describe these operating modes.

State mode

In State mode, the logic analyzer uses clock store qualification to capture address, data, and status information once during an instruction or data cycle. This mode is set up by the State configuration files. The State configuration files also automatically load the inverse assembler.

Timing mode

In Timing mode, the logic analyzer samples the microcontroller pins asynchronously, at a user-selected sampling rate. The Timing mode is set up by the Timing configuration files.

<p>State and Timing modes use different connectors on the preprocessor interface. The Timing pins are direct connections to the microcontroller signals. The State pins have active circuitry on the preprocessor interface. State information is acquired three target system clock cycles after the same information is captured in Timing mode.</p>
--

Format Menu

This section describes the organization of Motorola CPU32 signals in the logic analyzer's Format Menu.

The configuration software sets up the analyzer format menu to display pods. The following figures show the Format Menu for the Motorola CPU32 as configured on the HP 16550A.

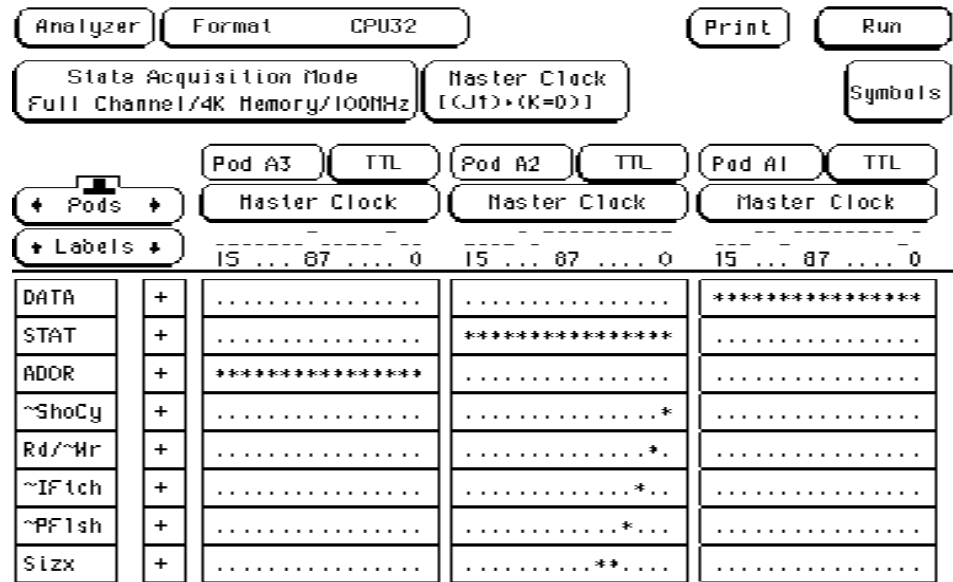

Format Specification (State)

Timing mode

If fewer than eight pods are available for timing, the logic analyzer will truncate the pods allocated. In this case, the logic analyzer Format menu shows the pod allocations. If the allocations will not acquire the desired signals, the allocations can be altered manually.

Analyzer Format 68332 Print Run

Timing Acquisition Mode
Conventional Full Channel 250 MHz

Symbols

Pod A3 TTL Pod A2 TTL Pod A1 TTL

+ Pods +

+ Labels +

		15 ... 87 ... 0	15 ... 87 ... 0	15 ... 87 ... 0
DATA	+	*****
Part H	+*****
Part G	+	*****.....
STAT	+	*****
Part E	+*****
~BR	+*
~BG	+*
~BGack	+*..

Format Menu (Timing)

Status bit definition and encodings

This section describes symbol information that has been set up by the preprocessor interface configuration software and information about the available inverse assemblers including filtering and debug monitors.

The table below is specifically for a state configuration. The timing configurations have many of the same signals, and those signals are represented by the same symbols used for state configurations.

HP E2480A STAT Bit Description

Bit	STAT Label	Description
0	-ShoCy	When this bit is asserted, it indicates the execution of an internal (show) cycle.
1	Rd/-Wr	Indicates the direction of the transfer.
2	-IFtch	Indicates the bus cycle is an instruction fetch.
3	-PFish	Indicates the instruction pipe has been flushed.
4:5	Sizx	Indicates the number of bytes being written or capable of being read.
6:7	DSAckx	Indicates the port size (in bytes) of the peripheral being read from/ written to.
8	-BErr	Indicates that the bus cycle terminated with an error.
9	-Freeze	When asserted, indicates the microcontroller is in background mode.
10	-Bkpt	Indicates a hardware breakpoint has been encountered.
11	-BGAck	When asserted, indicates the microcontroller does not own the bus.
12:14	FCx	These bits indicate the area of memory with which a transfer is taking place.

CPU32 Symbolic Representation of Status Bits

Label	Signal	Symbol	Value
~ShoCy	~Show_Cycle	Int	0
		Ext	1
Rd/~Wr	Rd/~Wr	Wr	0
		Rd	1
~IFtch	~Inst_Fetch	Fetch	0
		(blank)	1
~PFtsh	~Pipe_Flush	Flush	0
		(blank)	1
Sizx	Siz[0:1]	long	00
		byte	01
		word	10
		3byt	11
DSAckx	DSAck[0:1]	(blank)	00
		word	01
		byte	10
		wait	11
~BErr	~BErr	Error	0
		(blank)	1
~Freez	~Freeze	Bkgrnd	0
		Runnin	1
~Bkpt	~Bkpt	Break	0
		(blank)	1
~BGAck	~BGAck	NoBus	0
		(blank)	1
FCx	FC[0:2]	show	000
		user data	001
		user prgm	010
		(blank)	011
		(blank)	100
		supr data	101
supr prgm	110		
		CPU	111

Using the Inverse Assembler

This section discusses the general output format of the inverse assembler and controller-specific information. This section also assumes that an inverse assembler has been loaded.

To display captured state data

- Select the Listing Menu for your logic analyzer.

The logic analyzer displays captured state data in the Listing Menu. The inverse assembler display is obtained by setting the base for the DATA label to Invasm. The following figure shows a typical Listing Menu.

Analyzer	Listing	CPU32	Invasm Options	Print	Run
Markers Off	Acquisition Time 19 Mar 1997 16:25:27				
Label>	ADDR	CPU32 DATA		Rd/~Wr	~IFtch
Base>	Hex	mnemonic / hex		Hex	Hex
3	000410	ABCD.B	03,04	1	0
4	000412	JSR	0632	1	0
5	000414		user prog read	0632	1
6	000416	-ABCD.B	-(A0),-(A1)	1	0
7	0007FC		user data write	0000	0
8	0007FE		user data write	0416	0
9	000632	HQVEA.L	#00009000,A0	1	0
10	000634		user prog read	0000	1
11	000636		user prog read	9000	1
12	000638	HQVEA.L	#00009100,A1	1	0
13	00063A		user prog read	0000	1
14	00063C		user prog read	9100	1
15	00063E	HQVEA.L	#00009200,A2	1	0
16	000640		user prog read	0000	1
17	000642		user prog read	9200	1
18	000644	HQVEA.L	#00009300,A3	1	0

To synchronize the inverse assembler

The CPU32 microcontroller does not indicate externally which word fetched is the beginning of a new instruction. You may have to "point" to the first state of an instruction fetch to synchronize the inverse assembler. Once synchronized, the inverse assembler will disassemble from this state through the end of the screen. To synchronize the inverse assembler:

- **Identify a line on the display that you know is the first state of an instruction fetch.**
- **Roll this line to the top of the listing.**
- **Press the Invasm field at the top of the screen.**
This will cause the Invasm Options submenu to appear.
- **Press the Align softkey.**

The listing will inverse assemble from the top line down. Any data before this screen is left unchanged. Rolling the screen up will inverse assemble the lines as they appear on the bottom of the screen. If you jump to another area of the listing by entering a new line number or by rolling the screen down, you may have to re-synchronize the inverse assembler by repeating the described steps.

Each time you inverse assemble a block of memory, the analyzer will keep that block in the inverse assembled condition. You can inverse assemble several different blocks in the analyzer memory, but the activity between those blocks will not be inverse assembled.

General output format

The next few paragraphs describe the general output format of the inverse assemblers.

Numeric Format

Unless a value is followed by a suffix character, numeric output from the inverse assembler is in hexadecimal format. For example, decimal values have a period (.) as the suffix character; binary values have a percent sign (%).

Missing Opcodes/Operands

Asterisks (*) in the inverse assembler output indicate missing operands. Missing operands occur frequently and are primarily due to microcontroller prefetch activity. Storage qualification or the use of storage windows can also lead to such occurrences.

Don't Care Bytes

The CPU32 microcontroller can perform byte transfers. During operand reads and writes, entire 16-bit (word) values appear on the microcontroller data bus lines. The inverse assembler will attempt to display "xx" for any bytes in a transfer that is invalid. You can then determine exactly which byte of data was used as an operand. If the microcontroller is configured such that the number of bytes being transferred cannot be determined, an entire word will be displayed. You must then determine which bytes are valid.

Unexecuted Prefetched Instructions

Prefetched instructions which are not executed by the microcontroller are marked by a hyphen "-" in the first column of the mnemonic/hex field

The logic analyzer captures prefetches even if they are not executed. Care must be taken when specifying a trigger condition or a storage qualification that follows an instruction that may cause branching. An unused prefetch may generate an unwanted trigger.

Since the microcontroller only prefetches at most two words, one technique to avoid unwanted triggering from unused prefetches is to add "4" to the trigger address. This trigger condition will only be satisfied if the branch is not taken.

Processor-Specific Output Format

The logic analyzer captures all bus cycles. This includes background and coprocessor cycles as well as code cycles.

A "c" marks coprocessor activity, and background activity is marked with a "b". The "c" and "b" are displayed in the first column of the mnemonic/hex field. Acquisitions of coprocessor and background cycles may be individually enabled/disabled via the trigger menu.

General Missing Terms

Depending on the configuration of the microcontroller, the inverse assembler may be unable to supply all the of the information it can supply. For example, if ~DS (data strobe) is not valid, internal cycles cannot be captured.

Filtering

The CPU32 inverse assembler is capable of suppressing certain acquired cycles from the display, thus allowing the user to focus on and display more cycles of interest. The filter softkeys are part of the "Invasm Options" submenu. "Invasm Options" must be pressed to display the submenu.

Cycle suppression is broken down into the following categories: extension words, unexecuted prefetches, branches, calls and returns, other instructions, data reads, and data writes.

Extension words and unexecuted fetches are suppressed without regard to user mode or supervisor mode because they do not affect the display of executed mnemonics.

All other categories may suppress based on the user mode, supervisor mode, or both. These categories suppress actual executed mnemonics for the display.

Inverse assembler error messages

Any of the following list of error messages may appear during analysis of your target software. Included with each message is a brief explanation.

Fatal Data Error

Displayed if the trace memory could not be read properly on entry into the inverse assembler.

Illegal Opcode <code>

Displayed if the inverse assembler encounters an illegal instruction.

Reserved Opcode

Displayed if the inverse assembler encounters a reserved coprocessor instruction.

Incomplete Opcode

Displayed if the inverse assembly cannot acquire all words of a multi-word instruction.

*** (asterisk)**

Displayed if the inverse assembler cannot find a complete operand field for an instruction. Prefetch activity or storage qualification is often the cause.

Clock qualifiers

If you do want to acquire Background cycles, add "L=1" as a clock qualifier. If you do not want to acquire coprocessor cycles, add "M=1" as a clock qualifier.

Reference

Reference

This chapter contains additional reference information including the signal mapping for the HP E2480A Preprocessor Interface.

The information in this chapter is presented in the following sections:

- Operating characteristics
- Theory of operation and clocking
- Address-reconstruction overview
- Signal-to-connector mapping (timing)
- State connector signal definition
- Repair strategy
- Circuit board dimensions

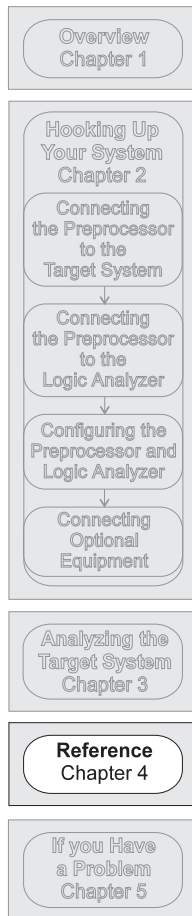

Operating Characteristics

The following operating characteristics are not specifications, but are typical operating characteristics for the preprocessor interface.

Product Characteristics

Microcontroller Supported	Motorola 68331, 68332, 68F333, 68334, 68335, 68336, 68338, or 68376
Package Supported	132-pin PQFP 144-pin TQFP 160-pin PQFP
Probes Required	Mandatory 4 for state. Up to 8 for timing.
Accessories Required	See chapter 1 for available accessories. A probe adapter and a transition board are required. For address reconstruction, the HP E3458A Processor Probe is required.
Optional Accessories	The HP E3458A Processor Probe connects to the preprocessor interface and provides Run Control.

Electrical Characteristics

Power Requirements	650 mA typical @ 5V, supplied by logic analyzer or the HP E3458A Processor Probe.
Signal Line Loading	10 pF maximum on all signals.

Environmental Characteristics

Temperature	Operating	0 to + 55 degrees C +32 to +131 degrees F
	Nonoperating	-40 to + 75 degrees C -40 to +167 degrees F
Altitude	Operating	4,600 m 15,000 feet
	Nonoperating	15,3000 m 50,000 feet
Humidity	Up to 90% noncondensing. Avoid sudden , extreme temperature changes which could cause condensation on the circuit board.	

Theory of Operation and Clocking

Timing

For timing measurements, raw digital signals from the microcontroller are presented to the logic analyzer through the timing connectors. The acquisition clock is provided by the logic analyzer.

State

For state measurements, all signals are processed by active logic for time alignment before they are routed to the state connectors. This allows the logic analyzer to capture all information about a given cycle in one acquisition state.

Some of the signals which assist the preprocessor in triggering and aligning the source code are reconstructed from their reconfigured functions as chip selects or general I/O. The preprocessor interface must be configured to match the target system for this reconstruction function to work.

A qualified target system clock is used by the logic analyzer to acquire state cycles.

Address reconstruction overview

When CPU32 microcontrollers are reconfigured, they can present special problems for debugging. This is especially true when address bits A[19:23] are reconfigured as chip selects. The HP E2480A Preprocessor Interface overcomes these problems by using information in the base address register associated with such chip selects to replace the missing address bits. The value injected into the signal path depends on which chip select is active. Refer to chapter 2 for information on programming the preprocessor interface.

This reconstruction provides many benefits when analyzing a target system:

- Triggering on address A0 through A23 is possible, even when the upper address bits are not available from the target microprocessor.
- The software analyzer, with its increased analysis capabilities, can be used.
- Code captured in a trace can be correlated with mnemonics in the source database.
- Alignment of activity shown in a trace list.

The HP E2480A also reconstructs function control bits FC[0:2] when they are configured as chip selects, and SIZ[0:1] and DSack[0:1] when they are configured as general I/O.

The programming is non-volatile. Once programmed, the HP E2480A does not need to remain connected to the processor probe to maintain address reconstruction.

The figure on the following page shows the process by which the HP E2480A reconstructs addresses.

State and Timing modes use different connectors on the preprocessor interface. The Timing pins are direct connections to the microcontroller signals. The State pins have active circuitry on the preprocessor interface. State information is acquired three target system clock cycles after the same information is captured in Timing mode.

Reference
Address reconstruction overview

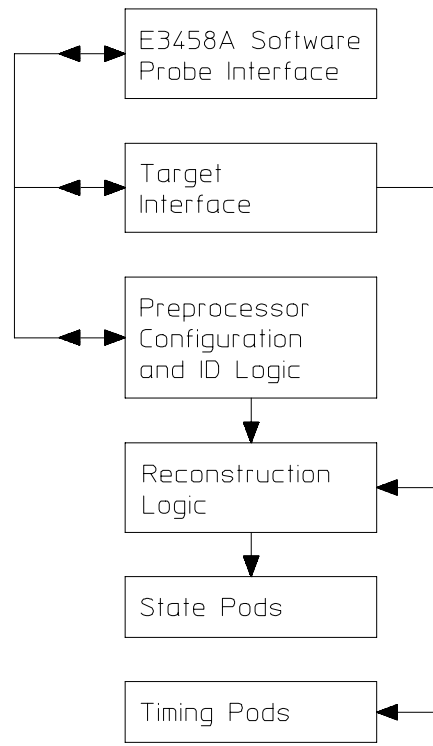

e2480b05

Address Reconstruction Overview

Signal-to-connector mapping (Timing)

The following table shows the flow of signals from the microcontroller through the E2480A timing connectors to the logic analyzer. In addition to being grouped along microprocessor-like functions, the signals are also grouped and ordered along their microcontroller port definitions.

CPU32 Signal List

CPU32 SIGNAL NAME	E2480A TIMING CONNECTOR PIN	ANALYZER BIT	TIMING LABEL	TIMING SUBLABEL
Timing Connector J5, Timing Pod 1				
DATA0	38	0	DATA	PORT H
DATA1	36	1	DATA	PORT H
DATA2	34	2	DATA	PORT H
DATA3	32	3	DATA	PORT H
DATA4	30	4	DATA	PORT H
DATA5	28	5	DATA	PORT H
DATA6	26	6	DATA	PORT H
DATA7	24	7	DATA	PORT H
DATA8	22	8	DATA	PORT G
DATA9	20	9	DATA	PORT G
DATA10	18	10	DATA	PORT G
DATA11	16	1	DATA	PORT G
DATA12	14	12	DATA	PORT G
DATA13	12	13	DATA	PORT G
DATA14	10	14	DATA	PORT G
DATA15	8	15	DATA	PORT G
ClkOut	6	CLK		

Reference
Signal-to-connector mapping (Timing)

CPU32 SIGNAL NAME	E2480A TIMING CONNECTOR PIN	ANALYZER BIT	TIMING LABEL	TIMING SUBLABEL
Timing Connector J5, Timing Pod 2				
~BR/CS0	37	0	STAT	CSx
~BG/CS1	35	1	STAT	CSx
~BGAck/CS2	33	2	STAT	CSx
DSAck0	31	3	STAT	PORT E
DSAck1	29	4	STAT	PORT E
~AVec	27	5	STAT	PORT E
~RMC	25	6	STAT	PORT E
~DS	23	7	STAT	PORT E
~AS	21	8	STAT	PORT E
SIZ0	19	9	STAT	PORT E
SIZ1	17	10	STAT	PORT E
R/~W	15	11	STAT	
~BERR	13	12	STAT	
~HALT	11	13	STAT	
~Targ_Reset	9	14	STAT	
~Freeze/Quote	7	15		
~CSBoot	5	CLK		

CPU32 SIGNAL NAME	E2480A TIMING CONNECTOR PIN	ANALYZER BIT	TIMING LABEL	TIMING SUBLABEL
Timing Connector J4, Timing Pod 3				
ADDR0	38	0	ADDR	
ADDR1	36	1	ADDR	
ADDR2	34	2	ADDR	
ADDR3	32	3	ADDR	PORT B
ADDR4	30	4	ADDR	PORT B
ADDR5	28	5	ADDR	PORT B
ADDR6	26	6	ADDR	PORT B
ADDR7	24	7	ADDR	PORT B
ADDR8	22	8	ADDR	PORT B
ADDR9	20	9	ADDR	PORT B
ADDR10	18	10	ADDR	PORT B
ADDR11	16	11	ADDR	PORT A
ADDR12	14	12	ADDR	PORT A
ADDR13	12	13	ADDR	PORT A
ADDR14	10	14	ADDR	PORT A
ADDR15	8	15	ADDR	PORT A

Reference
Signal-to-connector mapping (Timing)

CPU32 SIGNAL NAME	E2480A TIMING CONNECTOR PIN	ANALYZER BIT	TIMING LABEL	TIMING SUBLABEL	
Timing Connector J4, Timing Pod 4					
ADDR16	37	0	ADDR	PORT A	
ADDR17	35	1	ADDR	PORT A	
ADDR18	33	2	ADDR	PORT A	
FC0/CS3	31	3		PORT C	CSx
FC1/CS4	29	4		PORT C	CSx
FC2/CS5	27	5		PORT C	CSx
ADDR19/~CS6	25	6	ADDR	PORT C	CSx
ADDR20/~CS7	23	7	ADDR	PORT C	CSx
ADDR21/~CS8	21	8	ADDR	PORT C	CSx
ADDR22/~CS9	19	9	ADDR	PORT C	CSx
ADDR23/~CS10	17	10	ADDR	PORT C	CSx
na	15	11			
na	13	12			
na	11	13			
~IFetch/DS1	9	14			
~IPipe/DS0	7	15			
~Bkpt/DScLk	5	CLK			

NOTE: Signals A19—A23 and CS6—CS10 are multiplexed onto the same pins, and the default configuration of the logic analyzer assumes that signals A19—A23 are valid. If any of the chip selects, CS6—CS10, are being used then the bits associated with A19—A23 should be removed from the ADDR label via the format menu in the logic analyzer. This corresponds to bits 3—7 of pod A4. This results in the display of correct address information in the ADDR field of the listing menu and presents only valid address bus bits to the ADDR field in the trigger menu.

CPU32 SIGNAL NAME			E2480A TIMING CONNECTOR PIN	ANALYZER BIT	TIMING LABEL
Timing Connector J2, Timing Pod 5					
338	336, 376	333			
MISO	MISO	MISO	38	0	PORT Q
MOSI	MOSI	MOSI	36	1	PORT Q
SCK	SCK	SCK	34	2	PORT Q
PCS0/SS	PCS0/SS	PCS0/SS	32	3	PORT Q
PCS1	PCS1	PCS1	30	4	PORT Q
PCS2	PCS2	PCS2	28	5	PORT Q
PCS3	PCS3	PCS3	26	6	PORT Q
TxD	TxD	TxD	24	7	PORT Q
RxD	RxD	RxD	22	8	
CTS24B	CTM2C	nc	20	9	
CTS24A	CTD3	nc	18	10	
CTD29	CTD4	nc	16	1	
CTD28	CPWM5	nc	14	12	
CTD27	CPWM6	nc	12	13	
CTD26	CPWM7	nc	10	14	
CTM31L	CPWM8	nc	8	15	
SCK	SCK	SCK	6	CLK	

Reference
Signal-to-connector mapping (Timing)

CPU32 SIGNAL NAME			E2480A TIMING CONNECTOR PIN	ANALYZER BIT	TIMING LABEL
Timing Connector J2, Timing Pod 6					
338	376, 336, 335, 334, 333, 332	331			
CTIO0	TP0	nc	37	0	TPU
CTIO1	TP1	IC1	35	1	TPU
CTD10	TP2	IC2	33	2	TPU
CTD9	TP3	IC3	31	3	TPU
CTD8	TP4	OC1	29	4	TPU
CTD7	TP5	OC1/OC2	27	5	TPU
CTD6	TP6	OC1/OC3	25	6	TPU
CTD5	TP7	nc	23	7	TPU
CTD4	TP8	OC1/OC4	21	8	TPU
CTIO2	TP9	OC1/OC5/IC4	19	9	TPU
CTIO3	TP10	PAI	17	10	TPU
CTS14B	TP11	nc	15	11	TPU
CTS14A	TP12	nc	13	12	TPU
CTIO4	TP13	nc	11	13	TPU
CTIO5	TP14	PWMA	9	14	TPU
CTS18B	TP15	PWMB	7	15	TPU
CTS18A	T2clk	PClk	5	CLK	

CPU32 SIGNAL NAME			E2480A TIMING CONNECTOR PIN	ANALYZER BIT	TIMING LABEL
Timing Connector J3, Timing Pod 7					
338	336, 376	335, 334, 333, 332, 331			
ModClk	ModClk	ModClk	38	0	PORT F
IRQ1	IRQ1	IRQ1	36	1	PORT F
IRQ2	IRQ2	IRQ2	34	2	PORT F
IRQ3	IRQ3	IRQ3	32	3	PORT F
IRQ4	IRQ4	IRQ4	30	4	PORT F
IRQ5	IRQ5	IRQ5	28	5	PORT F
IRQ6	IRQ6	IRQ6	26	6	PORT F
IRQ7	IRQ7	IRQ7	24	7	PORT F
nc	CDT10	nc	22	8	
nc	CTD9/CTM2L	nc	20	9	
nc	nc	nc	18	10	
nc	nc	nc	16	11	
nc	nc	nc	14	12	
nc	nc	nc	12	13	
nc	nc	nc	10	14	
nc	nc	nc	8	15	

Reference
Signal-to-connector mapping (Timing)

CPU32 SIGNAL NAME				E2480A TIMING CONNECTOR PIN	ANALYZER BIT	TIMING LABEL
Timing Connector J3, Timing Pod 8 (338 is nc)						
336, 376	333	334	335, 332, 331			
A2D_A0	A2D_B0	nc	nc	37	0	
A2D_A1	A2D_B1	nc	nc	35	1	
A2D_A2	A2D_B2	nc	nc	33	2	
A2D_A3	A2D_B3	nc	nc	31	3	
A2D_A4	A2D_B4	nc	nc	29	4	
A2D_A5	A2D_B5	nc	nc	27	5	
A2D_A6	A2D_B6	nc	nc	25	6	
A2D_A7	A2D_B7	VDDA	MISO	23	7	PORT Q*
A2D_B0	A2D_A0	VSSA	MOSI	21	8	PORT Q*
A2D_B1	A2D_A1	A2D_A0	SCK	19	9	PORT Q*
A2D_B2	A2D_A2	A2D_A1	PCS0/SS	17	10	PORT Q*
A2D_B3	A2D_A3	A2D_A2	PCS1	15	11	PORT Q*
A2D_B4	A2D_A4	A2D_A3	PCS2	13	12	PORT Q*
A2D_B5	A2D_A5	A2D_A4	PCS3	11	13	PORT Q*
A2D_B6	A2D_A6	A2D_A5	TxD	9	14	PORT Q*
A2D_B7	A2D_A7	A2D_A6	RxD	7	15	
nc	nc	nc	nc	5	CLK	

*The PORT Q labels are valid only for the 331, 332, and 335 microprocessors.

State connector signal definition

The following table defines the state connectors, the logic analyzer bit assignments, and the label/sublabel(s) to which a signal belongs. This table aids in reconfiguring the logic analyzer to match a particular microcontroller configuration.

E2480A State Connector Signal List

CPU32 SIGNAL NAME	E2480A STATE CONNECTOR PIN	ANALYZER BIT	STATE LABEL	STATE SUBLABEL
State Connector J1, State Pod 1				
DATA0	38	0	DATA	
DATA1	36	1	DATA	
DATA2	34	2	DATA	
DATA3	32	3	DATA	
DATA4	30	4	DATA	
DATA5	28	5	DATA	
DATA6	26	6	DATA	
DATA7	24	7	DATA	
DATA8	22	8	DATA	
DATA9	20	9	DATA	
DATA10	18	10	DATA	
DATA11	16	1	DATA	
DATA12	14	12	DATA	
DATA13	12	13	DATA	
DATA14	10	14	DATA	
DATA15	8	15	DATA	
ClkOut	6	CLK		

Reference
State connector signal definition

CPU32 SIGNAL NAME	E2480A STATE CONNECTOR PIN	ANALYZER BIT	STATE LABEL	STATE SUBLABEL
State Connector J1, State Pod 2				
~SHOW_CYCLE	37	0	STAT	~ShoCy
R/~W	35	1	STAT	R/~W
~INST_FETCH	33	2	STAT	~IFtch
~PIPE_FLUSH	31	3	STAT	~PFish
SIZ0	29	4	STAT	SIZx
SIZ1	27	5	STAT	SIZx
DSAck0	25	6	STAT	DSACKx
DSAck1	23	7	STAT	DSACKx
~BERR	21	8	STAT	~BErr
~Freeze	19	9	STAT	~Freez
~Bkpt	17	10	STAT	~Bkpt
~BGAck	15	11	STAT	~BGAck
FC0	13	12	STAT	FCx
FC1	11	13	STAT	FCx
FC2	9	14	STAT	FCx
na	7	15		
~Analyzer_clk_en	5	CLK		

CPU32 SIGNAL NAME	E2480A STATE CONNECTOR PIN	ANALYZER BIT	STATE LABEL	STATE SUBLABEL
State Connector J6, State Pod 3				
ADDR0	38	0	ADDR	
ADDR1	36	1	ADDR	
ADDR2	34	2	ADDR	
ADDR3	32	3	ADDR	
ADDR4	30	4	ADDR	
ADDR5	28	5	ADDR	
ADDR6	26	6	ADDR	
ADDR7	24	7	ADDR	
ADDR8	22	8	ADDR	
ADDR9	20	9	ADDR	
ADDR10	18	10	ADDR	
ADDR11	16	11	ADDR	
ADDR12	14	12	ADDR	
ADDR13	12	13	ADDR	
ADDR14	10	14	ADDR	
ADDR15	8	15	ADDR	
-Freeze	6	CLK		

Reference
State connector signal definition

CPU32 SIGNAL NAME	E2480A STATE CONNECTOR PIN	ANALYZER BIT	STATE LABEL	STATE SUBLABEL
State Connector J6, State Pod 4				
ADDR16	37	0	ADDR	
ADDR17	35	1	ADDR	
ADDR18	33	2	ADDR	
ADDR19	31	3	ADDR	
ADDR20	29	4	ADDR	
ADDR21	27	5	ADDR	
ADDR22	25	6	ADDR	
ADDR23	23	7	ADDR	
~BGack	5	CLK		

Repair Strategy

The repair strategy for this preprocessor interface is board replacement. However, the following table lists some mechanical parts that may be replaced if they are damaged or lost. Contact your nearest Hewlett-Packard Sales Office for further information on servicing the board.

Exchange assemblies are available when a repairable assembly is returned to Hewlett-Packard. These assemblies have been set up on the "Exchange Assembly" program. This allows you to exchange a faulty assembly with one that has been repaired, calibrated, and performance verified by the factory. The cost is significantly less than that of a new assembly.

Replaceable Parts

HP Part Number	Description
HP E2480A	
E2480-69502	Circuit board assembly
E2480-68701	Inverse assembler disk pouch
5041-9491	Extraction Tool
E5346A	Flexible Adapter Cable
HP E8115A	
E3417A	Generic 132-Pin QFP Probe
E8119A	132-pin QFP-FC 6833X Transition Board
HP E8116A	
E5336A	144-Pin Elas Probe
E5338A	144-pin TQFP 68332 Adapter
E8120A	144-pin QFP-FV 6833X Transition Board
HP E8118A	
E5350A	176-pin TQFP Generic Flex
E5373A	160-pin QFP Elast Probe Adapt
E8122A	160-pin QFP-FT 68336 Transition Board

Circuit Board Dimensions

The following figure gives the dimensions for the preprocessor interface assembly. The dimensions are listed in inches and millimeters.

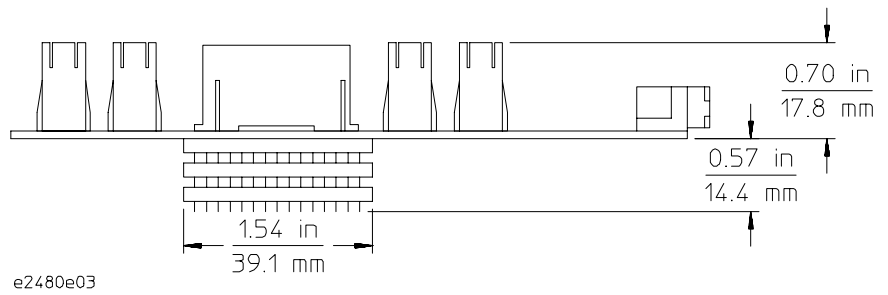
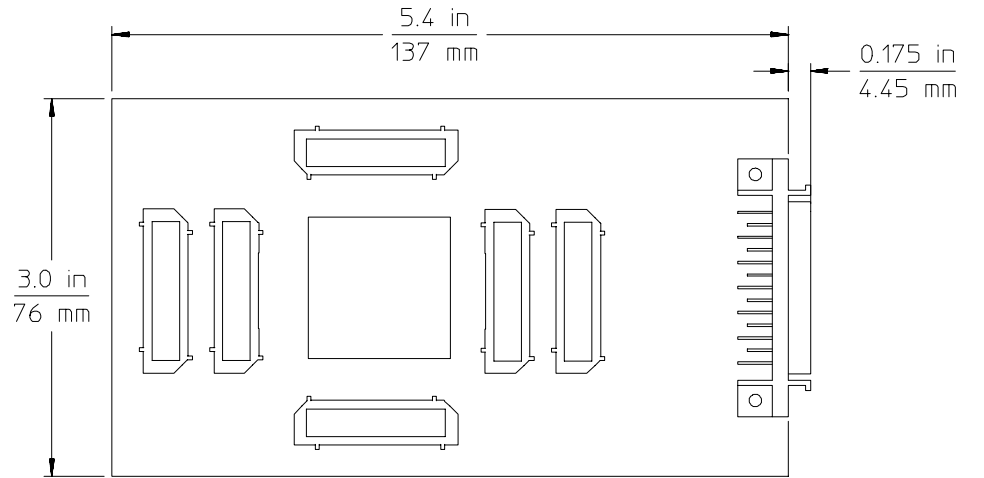

Circuit Board Dimension Diagram

If You Have a Problem

If You Have a Problem

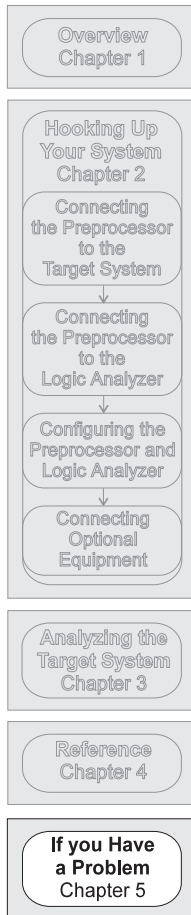

Occasionally, a measurement may not give the expected results. If you encounter difficulties while making measurements, use this chapter to guide you through some possible solutions. Each heading lists a problem you may encounter, along with some possible solutions.

The information in this chapter is presented in the following sections:

- Analyzer problems
- Preprocessor problems
- Inverse assembler problems
- Intermodule measurement problems
- Messages
- Cleaning the instrument

If you still have difficulty using the analyzer after trying the suggestions in this chapter, please contact your local Hewlett-Packard service center.

CAUTION

When you are working with the analyzer, be sure to power down both the analyzer and the target system before disconnecting or connecting cables, probes, and preprocessors. Otherwise, you may damage circuitry in the analyzer, preprocessor, or target system.

Analyzer Problems

This section lists general problems that you might encounter while using the analyzer.

Intermittent data errors

This problem is usually caused by poor connections, incorrect signal levels, or marginal timing.

- Remove and reseat all cables and probes, ensuring that there are no bent pins on the preprocessor interface or poor probe connections.
- Adjust the threshold level of the data pod to match the logic levels in the system under test.
- Use an oscilloscope to check the signal integrity of the data lines.

Clock signals for the state analyzer must meet particular pulse shape and timing requirements. Data inputs for the analyzer must meet pulse shape and setup and hold time requirements.

See Also

See “Capacitive Loading” in this chapter for information on other sources of intermittent data errors.

Unwanted triggers

Unwanted triggers can be caused by instructions that were fetched but not executed.

- Add the prefetch queue or pipeline depth to the trigger address to avoid this problem.

The logic analyzer captures prefetches, even if they are not executed. When you are specifying a trigger condition or a storage qualification that follows an instruction that may cause branching, an unused prefetch may generate an unwanted trigger.

No activity on activity indicators

- Check for loose cables, board connections, and preprocessor interface connections.
 - Check for bent or damaged pins on the preprocessor probe.
-

No trace list display

If there is no trace list display, it may be that your trigger specification is not correct for the data you want to capture, or that the trace memory is only partially filled.

- Check your trigger sequencer specification to ensure that it will capture the events of interest.
 - Try stopping the analyzer; if the trace list is partially filled, this should display the contents of trace memory.
-

Analyzer won't power up

If logic analyzer power is cycled when the logic analyzer is connected to a target system or software probe that remains powered up, the logic analyzer may not be able to power up. Some logic analyzers are inhibited from powering up when they are connected to a target system or software probe that is already powered up.

- Disconnect all logic analyzer cabling from the preprocessor. This will allow the logic analyzer to power up. Reconnect logic analyzer cabling after power up.

Preprocessor Problems

This section lists problems that you might encounter when using a preprocessor. If the solutions suggested here do not correct the problem, you may have a damaged preprocessor. Contact your local Hewlett-Packard Sales Office if you need further assistance.

Target system will not boot up

If the target system will not boot up after connecting the preprocessor interface, the microprocessor (if socketed) or the preprocessor interface may not be installed properly, or they may not be making electrical contact.

- Ensure that you are following the correct power-on sequence for the preprocessor and target system.

- 1** Power up the analyzer and preprocessor.
- 2** Power up the target system.

If you power up the target system before you power up the preprocessor, interface circuitry in the preprocessor may latch up and prevent proper target system operation.

- Verify that the microprocessor and the preprocessor interface are properly rotated and aligned, so that the index pin on the microprocessor (pin A1) matches the index pin on the preprocessor interface.
- Verify that the microprocessor and the preprocessor interface are securely inserted into their respective sockets.
- Verify that the logic analyzer cables are in the proper sockets of the preprocessor interface and are firmly inserted.

Erratic trace measurements

There are several general problems that can cause erratic variations in trace lists and inverse assembly failures.

- Do a full reset of the target system before beginning the measurement.**

Some preprocessor designs require a full reset to ensure correct configuration.

- Ensure that your target system meets the timing requirements of the processor with the preprocessor probe installed.**

See “Capacitive Loading” in this chapter. While preprocessor loading is slight, pin protectors, extenders, and adapters may increase it to unacceptable levels. If the target system design has close timing margins, such loading may cause incorrect processor functioning and give erratic trace results.

- Ensure that you have sufficient cooling for the microprocessor.**

Microprocessors such as the i486, Pentium™, and MC68040 generate substantial heat. This is exacerbated by the active circuitry on the preprocessor board. You should ensure that you have ambient temperature conditions and airflow that meet or exceed the requirements of the microprocessor manufacturer.

Capacitive loading

Excessive capacitive loading can degrade signals, resulting in incorrect capture by the preprocessor interface, or system lockup in the microprocessor. All preprocessor interfaces add additional capacitive loading, as can custom probe fixtures you design for your application.

Careful layout of your target system can minimize loading problems and result in better margins for your design. This is especially important for systems that are running at frequencies greater than 50 MHz.

- Remove as many pin protectors, extenders, and adapters as possible.**
- If multiple preprocessor interface solutions are available, use one with lower capacitive loading.**

Inverse Assembler Problems

This section lists problems that you might encounter while using the inverse assembler.

When you obtain incorrect inverse assembly results, it may be unclear whether the problem is in the preprocessor or in your target system. If you follow the suggestions in this section to ensure that you are using the preprocessor and inverse assembler correctly, you can proceed with confidence in debugging your target system.

No inverse assembly or incorrect inverse assembly

This problem may be due to incorrect synchronization, modified configuration, incorrect connections, or a hardware problem in the target system. A locked status line can cause incorrect or incomplete inverse assembly.

- Ensure that each logic analyzer pod is connected to the correct preprocessor connector.**

There is not always a one-to-one correspondence between analyzer pod numbers and preprocessor cable numbers. Preprocessors must supply address (ADDR), data (DATA), and status (STAT) information to the analyzer in a predefined order. The cable connections for each preprocessor are often altered to support that need. Thus, one preprocessor might require that you connect cable 2 to analyzer pod 2, while another will require you to connect cable 5 to analyzer pod 2. See Chapter 2 for connection information.

- Check the activity indicators for status lines locked in a high or low state.**
- Verify that the STAT, DATA, and ADDR format labels have not been modified from their default values.**

These labels must remain as they are configured by the configuration file. Do not change the names of these labels or the bit assignments within the labels. Some preprocessors also require other data labels. See Chapter 3 for more information.

- Verify that all microprocessor caches and memory managers have been disabled.

In most cases, if the microprocessor caches and memory managers remain enabled you should still get inverse assembly. It may be incorrect because a portion of the execution trace was not visible to the logic analyzer.

- Verify that storage qualification has not excluded storage of all the needed opcodes and operands.

Inverse assembler will not load or run

You need to ensure that you have the correct system software loaded on your analyzer.

- Ensure that the inverse assembler is on the same disk as the configuration files you are loading.**

Configuration files for the state analyzer contain a pointer to the name of the corresponding inverse assembler. If you delete the inverse assembler or rename it, the configuration process will fail to load the disassembler.

See Chapter 2 for details.

Intermodule Measurement Problems

Some problems occur only when you are trying to make a measurement involving multiple modules.

An event wasn't captured by one of the modules

If you are trying to capture an event that occurs very shortly after the event that arms one of the measurement modules, it may be missed due to internal analyzer delays. For example, suppose you set the oscilloscope to trigger upon receiving a trigger signal from the logic analyzer because you are trying to capture a pulse that occurs right after the analyzer's trigger state. If the pulse occurs too soon after the analyzer's trigger state, the oscilloscope will miss the pulse.

- Adjust the skew in the Intermodule menu.**

You may be able to specify a skew value that enables the event to be captured.

- Change the trigger specification for modules upstream of the one with the problem.**

If you are using a logic analyzer to trigger the scope, try specifying a trigger state one state before the one you are using. This may be more difficult than working with the skew because the prior state may occur more often and not always be related to the event you are trying to capture with the oscilloscope.

Messages

This section lists some of the messages that the analyzer displays when it encounters a problem.

“... Inverse Assembler Not Found”

This error occurs if you rename or delete the inverse assembler file that is attached to the configuration file. Ensure that the inverse assembler file is not renamed or deleted, and that it is located in the same directory as the configuration file.

“Measurement Initialization Error”

This error occurs when you have installed the cables incorrectly for one or two HP 16550A logic analysis cards. The following diagrams show the correct cable connections for one-card and two-card installations. Ensure that your cable connections match the silk screening on the card, and that they are fully seated in the connectors. Then, repeat the measurement.

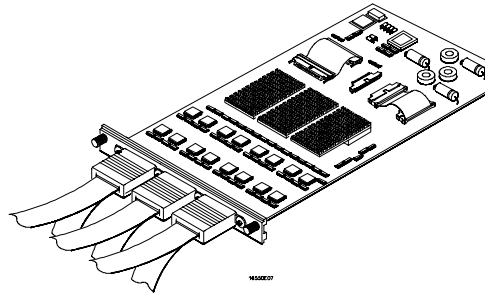

Cable Connections for One-Card HP 16550A Installations

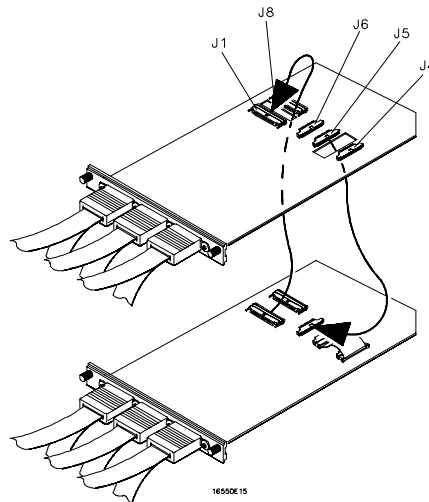

Cable Connections for Two-Card HP 16550A Installations

See Also

The *HP 16550A 100-MHz State/500-MHz Timing Logic Analyzer Service Guide*.

“No Configuration File Loaded”

This is usually caused by trying to load a configuration file for one type of module/system into a different type of module/system.

- Verify that the appropriate module has been selected from the Load {module} from File {filename} in the HP 16500A/B/C disk operation menu. Selecting Load {All} will cause incorrect operation when loading most preprocessor interface configuration files.

See Also

Chapter 2 describes how to load configuration files.

“Selected File is Incompatible”

This occurs when you try to load a configuration file for the wrong module. Ensure that you are loading the appropriate configuration file for your logic analyzer.

“Slow or Missing Clock”

- This error message might occur if the logic analyzer cards are not firmly seated in the HP 16500A/B/C or HP 16501A frame. Ensure that the cards are firmly seated.
- This error might occur if the target system is not running properly. Ensure that the target system is on and operating properly.
- If the error message persists, check that the logic analyzer pods are connected to the proper connectors on the preprocessor interface. See Chapter 2 to determine the proper connections.

“Time from Arm Greater Than 41.93 ms”

The state/timing analyzers have a counter to keep track of the time from when an analyzer is armed to when it triggers. The width and clock rate of this counter allow it to count for up to 41.93 ms before it overflows. Once the counter has overflowed, the system does not have the data it needs to calculate the time between module triggers. The system must know this time to be able to display data from multiple modules on a single screen.

“Waiting for Trigger”

If a trigger pattern is specified, this message indicates that the specified trigger pattern has not occurred. Verify that the triggering pattern is correctly set.

- When analyzing microprocessors that fetch only from word-aligned addresses, if the trigger condition is set to look for an opcode fetch at an address not corresponding to a word boundary, the trigger will never be found.

Cleaning the Instrument

If this instrument requires cleaning, disconnect it from all power sources and clean it with a mild detergent and water. Make sure the instrument is completely dry before reconnecting it to a power source.

© Copyright Hewlett-Packard Company 1997
All Rights Reserved.

Reproduction, adaptation, or translation without prior written permission is prohibited, except as allowed under the copyright laws.

Restricted Rights Legend

Use, duplication, or disclosure by the U.S. Government is subject to restrictions set forth in subparagraph (C) (1) (ii) of the Rights in Technical Data and Computer Software Clause in DFARS 252.227-7013.

Hewlett-Packard Company,
3000 Hanover Street, Palo Alto, CA 94304 U.S.A.
Rights for non-DOD U.S. Government Departments and Agencies are set forth in FAR 52.227-19(c)(1,2).

Document Warranty

The information contained in this document is subject to change without notice.

Hewlett-Packard makes no warranty of any kind with regard to this material, including, but not limited to, the implied warranties of merchantability or fitness for a particular purpose.

Hewlett-Packard shall not be liable for errors contained herein or for damages in connection with the furnishing, performance, or use of this material.

Safety

This apparatus has been designed and tested in accordance to International Safety Requirements. To ensure safe operation and to keep the product safe, the information, cautions, and warnings in this user's guide must be heeded. In addition, note the external markings on the product that are described under "Safety Symbols."

Safety Symbols



Instruction manual symbol: the product is marked with this symbol when it is necessary for you to refer to the instruction manual in order to protect against damage to the product.



Hazardous voltage symbol.



Earth terminal symbol: Used to indicate a circuit common connected to grounded chassis.

WARNING

The Warning sign denotes a hazard. It calls attention to a procedure, practice, or the like, which, if not correctly performed or adhered to, could result in personal injury. Do not proceed beyond a Warning sign until the indicated conditions are fully understood and met.

CAUTION

The Caution sign denotes a hazard. It calls attention to an operating procedure, practice, or the like, which, if not correctly performed or adhered to, could result in damage to or destruction of part or all of the product. Do not proceed beyond a Caution symbol until the indicated conditions are fully understood or met.

Product Warranty

This Hewlett-Packard product has a warranty against defects in material and workmanship for a period of one year from date of shipment. During the warranty period, Hewlett-Packard Company will, at its option, either repair or replace products that prove to be defective. For warranty service or repair, this product must be returned to a service facility designated by Hewlett-Packard.

For products returned to Hewlett-Packard for warranty service, the Buyer shall prepay shipping charges to Hewlett-Packard and Hewlett-Packard shall pay shipping charges to return the product to the Buyer. However, the Buyer shall pay all shipping charges, duties, and taxes for products returned to Hewlett-Packard from another country.

Hewlett-Packard warrants that its software and firmware designated by Hewlett-Packard for use with an instrument will execute its programming instructions when properly installed on that instrument.

Hewlett-Packard does not warrant that the operation of the instrument software, or firmware will be uninterrupted or error free.

Limitation of Warranty

The foregoing warranty shall not apply to defects resulting from improper or inadequate maintenance by the Buyer, Buyer-supplied software or interfacing, unauthorized modification or misuse, operation outside of the environmental specifications for the product, or improper site preparation or maintenance.

No other warranty is expressed or implied. Hewlett-Packard specifically disclaims the implied warranties of merchantability or fitness for a particular purpose.

Exclusive Remedies

The remedies provided herein are the buyer's sole and exclusive remedies. Hewlett-Packard shall not be liable for any direct, indirect, special, incidental, or consequential damages, whether based on contract, tort, or any other legal theory.

Assistance

Product maintenance agreements and other customer assistance agreements are available for Hewlett-Packard products.

For any assistance, contact your nearest Hewlett-Packard Sales Office.

Certification

Hewlett-Packard Company certifies that this product met its published specifications at the time of shipment from the factory. Hewlett-Packard further certifies that its calibration measurements are traceable to the United States National Institute of Standards and Technology, to the extent allowed by the Institute's calibration facility, and to the calibration facilities of other International Standards Organization members.

About this edition

This is the *HP E2480A Motorola CPU32 Preprocessor Interface User's Guide*.

Publication number
E2480-97001, May 1997
Printed in USA.

Print history is as follows:
E2480-97001, May 1997
E2480-97000, April 1997

New editions are complete revisions of the manual. Many product updates do not require manual changes; and, conversely, manual corrections may be done without accompanying product changes. Therefore, do not expect a one-to-one correspondence between product updates and manual updates.